

WHEELCHAIR RAMP DETAIL 'A'
SCALE: 1"=5'

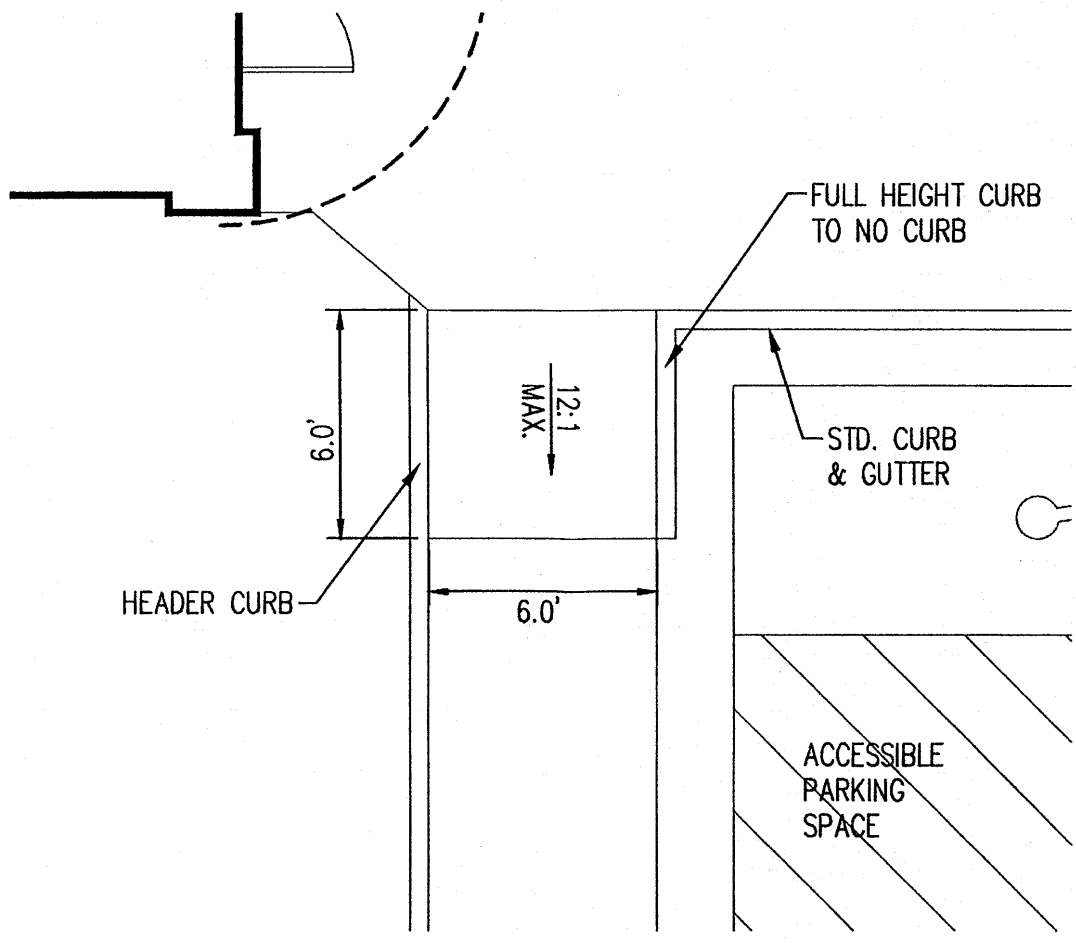

WHEELCHAIR RAMP DETAIL 'C'
SCALE: 1"=5'

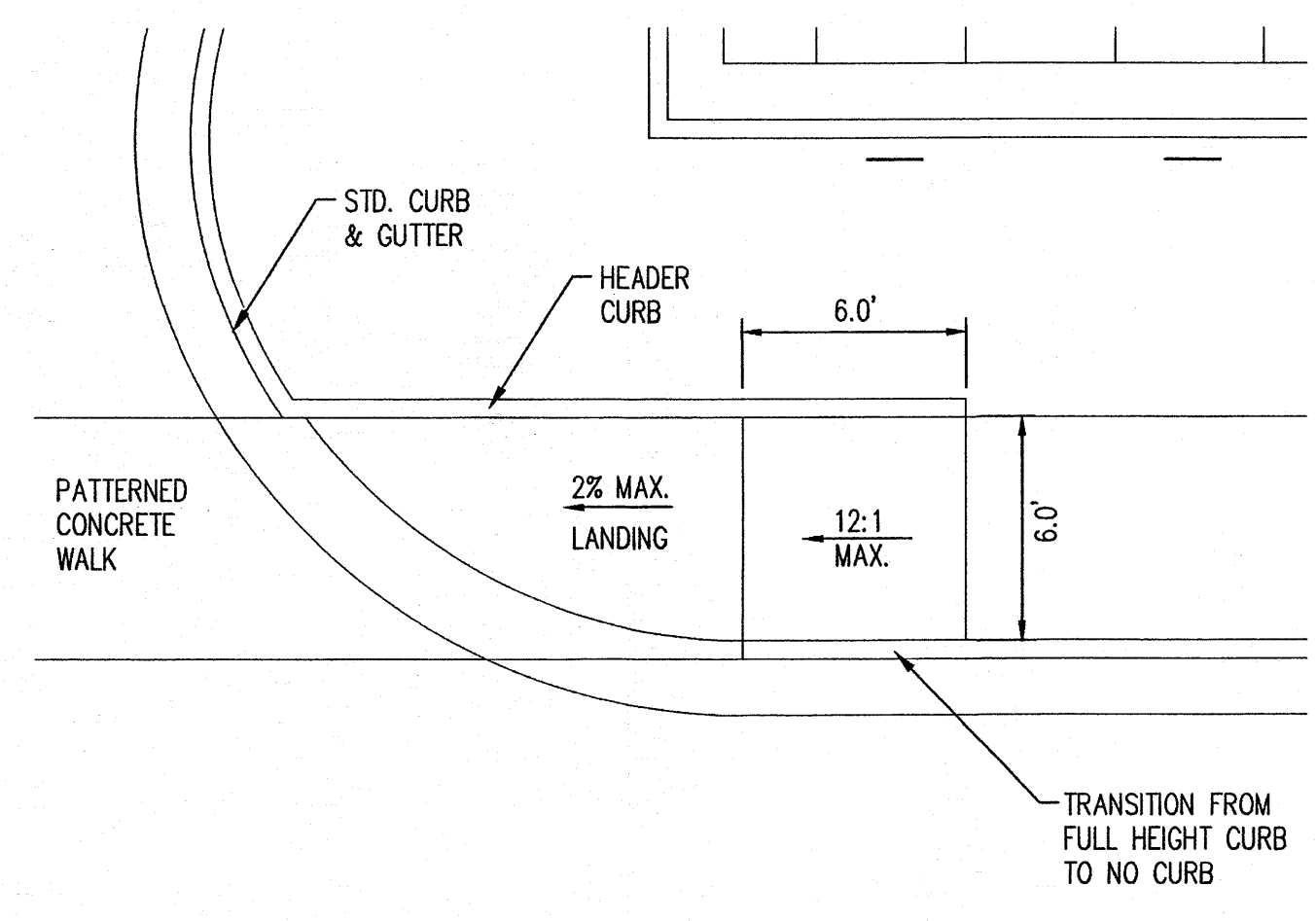

WHEELCHAIR RAMP DETAIL 'E'
SCALE: 1"=5'

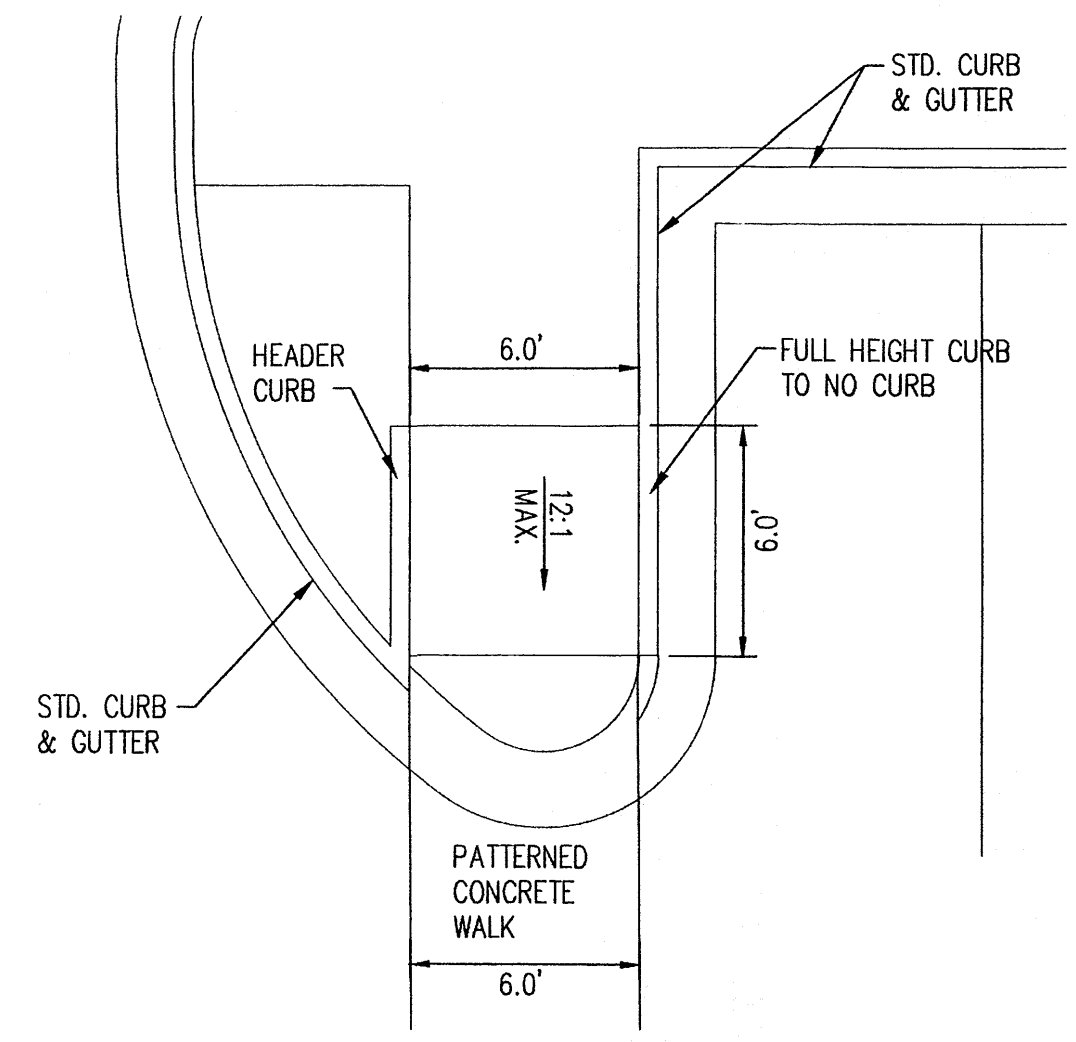

WHEELCHAIR RAMP DETAIL 'B'
SCALE: 1"=5'

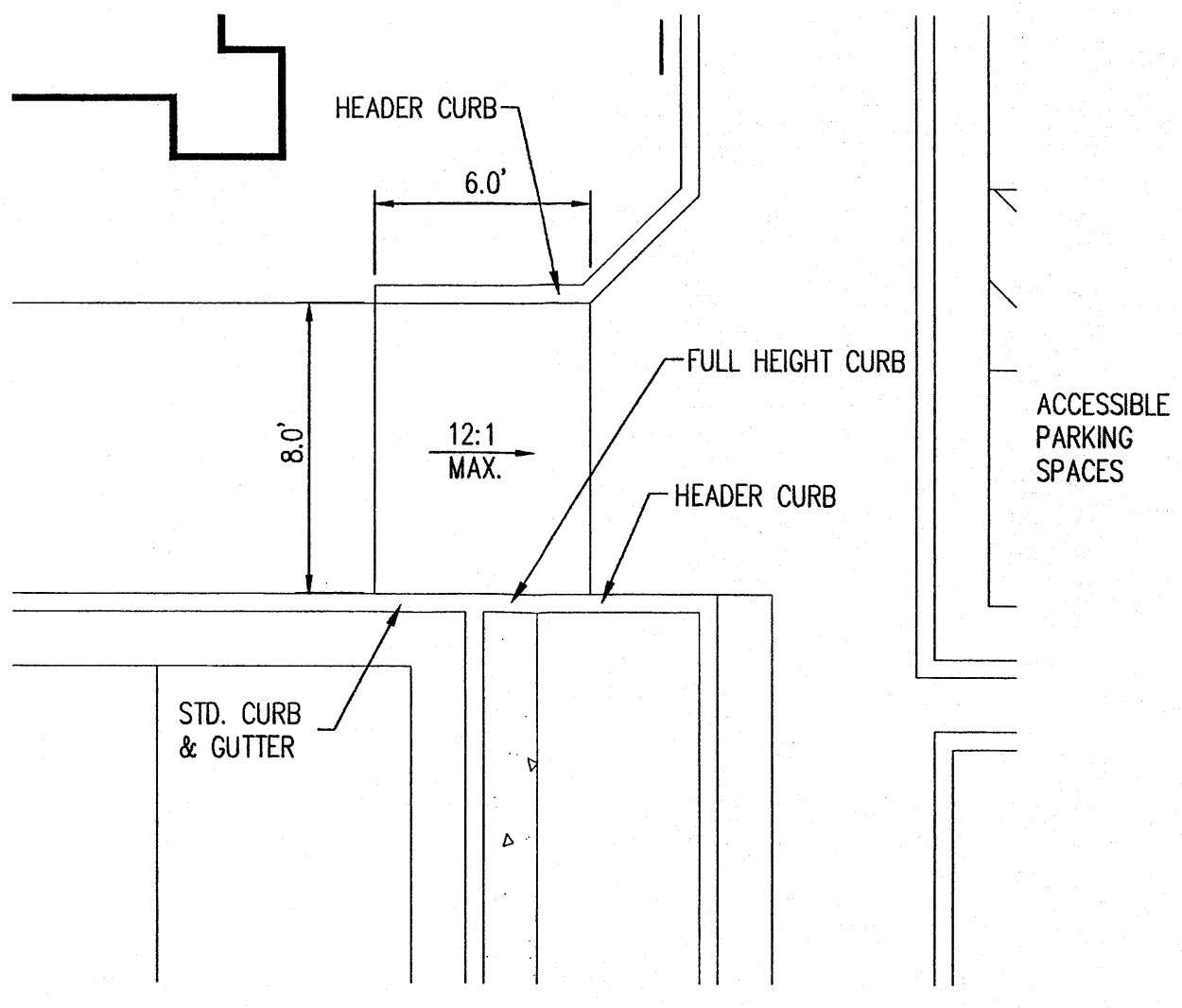

WHEELCHAIR RAMP DETAIL 'D'
SCALE: 1"=5'



CHEDDAR'S
CATERING, CHINA, ETC.

**WHEELCHAIR RAMP
DETAILS**
SCALE AS NOTED

REV.	DATE	DESCRIPTION
-	-	-

PROJECT: _____
SHEET: _____

Bohannon & Huston

FEBRUARY 5, 2013

1A

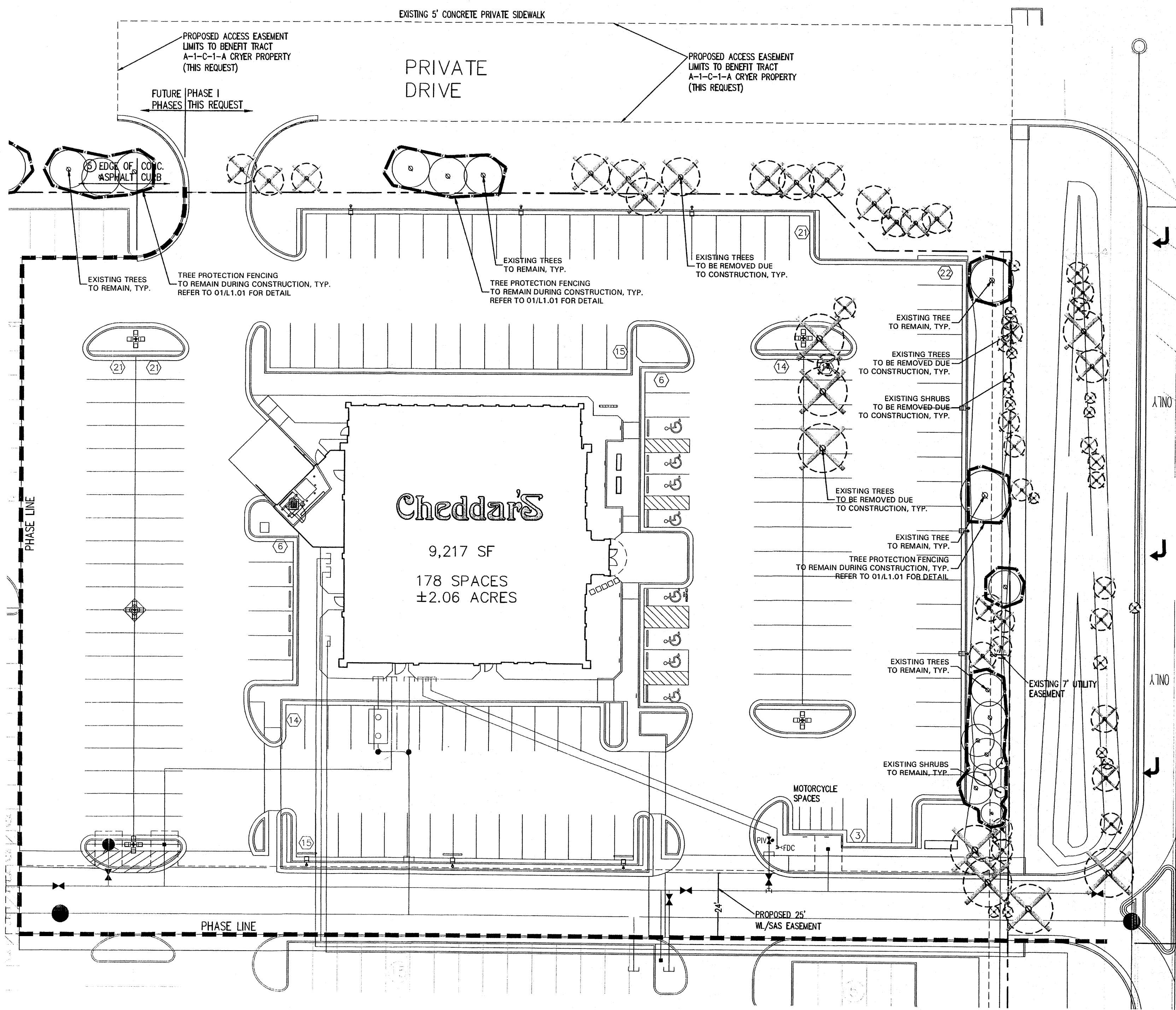

PRUNING AND TRIMMING NOTES

- CONTRACTOR SHALL PRUNE ALL EXISTING TREES ON-SITE USING THE FOLLOWING GUIDELINES.
- ALL TREES SHALL BE TRIMMED SO THAT NATURAL SHAPES OF THE PLANTS ARE RETAINED.
- DO NOT 'TOP' OR 'HEAD' TREES.
- IF BALLING OR SHEARING OF TREES HAS OCCURRED IN THE PAST, DISCONTINUE THIS PRACTICE AND ALLOW PLANTS TO GROW INTO NATURAL SHAPE.
- REMOVE SUCKERS, DEAD, DYING, DISEASED, BROKEN AND / OR WEAK BRANCHES FROM ALL TREES ALONG THE MAIN TRUNK STRUCTURE AND WITHIN THE BRANCHING AREA.
- CONTRACTOR SHALL PRUNE EXISTING DECIDUOUS HARDWOOD AND ORNAMENTAL TREES BY REMOVING LOWER LIMBS TO RAISE THE CANOPY. THE BOTTOM OF THE CANOPY SHALL BE RAISED TO 12'-0" ABOVE GRADE FOR DECIDUOUS HARDWOOD TREES AND 8'-0" HEIGHT ABOVE GRADE FOR ORNAMENTAL TREES, WHEN POSSIBLE. THE INTEGRITY OF THE CANOPY AND STRUCTURE OF THE TREE SHALL BE MAINTAINED. DO NOT CUT OR PRUNE CENTRAL LEADERS.
- CONTRACTOR SHALL THIN THE CANOPY BY ONE-FOURTH. PRUNE TREE TO EVENLY SPACE BRANCHES WITHIN THE CANOPY WHENEVER POSSIBLE. REMOVE THOSE LIMBS THAT CROSS OTHERS, DOUBLE LEADERS AND THOSE THAT EXCESSIVELY EXTEND BEYOND THE NATURAL CROWN OF THE TREE.
- CONTRACTOR SHALL PROVIDE DEEP ROOT FEEDING AND INVIGORATION OF EXISTING TREES. THIS SHALL BE ORGANIC BASED NUTRIENTS BASED FOR ROOT GROWTH AND LEAF GROWTH STIMULATION.
- CONTRACTOR SHALL BE REQUIRED TO CHIP ALL REMOVED BRANCHES, LEAFS, ETC.

TREE PRESERVATION NOTES

- EXISTING TREES TO REMAIN SHALL BE PROTECTED DURING CONSTRUCTION FROM TREE STRUCTURE DAMAGE AND COMPACTION OF SOIL UNDER AND AROUND DRIP LINE (CANOPY) OF TREE.
- IF ANY ROOT STRUCTURE IS DAMAGED DURING ADJACENT EXCAVATION / CONSTRUCTION, NOTIFY OWNER'S AUTHORIZED REPRESENTATIVE IMMEDIATELY. IT IS RECOMMENDED THAT A LICENSED ARBORIST BE SECURED FOR THE TREATMENT OF ANY POSSIBLE TREE WOUNDS.
- NO DISTURBANCE OF THE SOIL GREATER THAN 4" SHALL BE LOCATED CLOSER TO THE TREE TRUNK THAN 1/2 THE DISTANCE OF THE DRIP LINE TO THE TREE TRUNK. A MINIMUM OF 75% OF THE DRIP LINE AND ROOT ZONE SHALL BE PRESERVED AT NATURAL GRADE.
- ANY FINE GRADING DONE WITHIN THE CRITICAL ROOT ZONES OF THE PROTECTED TREES MUST BE DONE WITH LIGHT MACHINERY SUCH AS A BOBCAT OR LIGHT TRACTOR. NO EARTH MOVING EQUIPMENT WITH TRACKS IS ALLOWED WITHIN THE CRITICAL ROOT ZONE OF THE TREES.
- NO MATERIALS INTENDED FOR USE IN CONSTRUCTION OR WASTE MATERIALS ACCUMULATED DUE TO EXCAVATION OR DEMOLITION SHALL BE PLACED WITHIN THE LIMITS OF THE DRIP LINE OF ANY TREE.
- NO EQUIPMENT MAY BE CLEANED OR TOXIC SOLUTIONS, OR OTHER LIQUID CHEMICALS, SHALL BE DEPOSITED WITHIN THE LIMITS OF THE DRIP LINE OF A TREE, INCLUDING BUT NOT LIMITED TO: PAINT, OIL, SOLVENTS, ASPHALT, CONCRETE, MORTAR, PRIMERS, ETC.
- NO SIGNS, WIRES OR OTHER ATTACHMENTS, OTHER THAN THOSE OF A PROTECTIVE NATURE, SHALL BE ATTACHED TO ANY TREE.
- NO VEHICULAR / CONSTRUCTION EQUIPMENT TRAFFIC OR PARKING IS ALLOWED WITHIN THE LIMITS OF THE DRIP LINE OF TREES.
- BORING OF UTILITIES MAY BE PERMITTED UNDER PROTECTED TREES IN CERTAIN CIRCUMSTANCES. THE MINIMUM LENGTH OF THE BORE SHALL BE THE WIDTH OF THE TREE'S CANOPY AND SHALL BE A MINIMUM DEPTH OF FORTY-EIGHT (48") INCHES.
- IRRIGATION TRENCHING WHICH MUST BE DONE WITHIN THE CRITICAL ROOT ZONE OF A TREE SHALL BE DUG BY HAND AND ENTER THE AREA IN A RADIAL MANNER.
- ALL TREES TO BE REMOVED FROM THE SITE SHALL BE FLAGGED BY THE CONTRACTOR WITH BRIGHT RED VINYL TAPE (3" WIDTH) WRAPPED AROUND THE MAIN TRUNK AT A HEIGHT OF FOUR (4') FEET ABOVE GRADE. FLAGGING SHALL BE APPROVED BY OWNER'S AUTHORIZED REPRESENTATIVE PRIOR TO ANY TREE REMOVAL. CONTRACTOR SHALL CONTACT OWNER'S AUTHORIZED REPRESENTATIVE WITH 72 HOURS NOTICE TO SCHEDULE ON-SITE MEETING.
- ALL TREES TO REMAIN, AS NOTED ON DRAWINGS, SHALL HAVE PROTECTIVE FENCING LOCATED AT THE TREE'S DRIP LINE. THE PROTECTIVE FENCING MAY BE COMPRISED OF SNOW FENCING, ORANGE VINYL CONSTRUCTION FENCING, CHAIN LINK FENCE OR OTHER SIMILAR FENCING WITH A FOUR (4') FOOT APPROXIMATE HEIGHT. THE PROTECTIVE FENCING SHALL BE LOCATED AS INDICATED ON THE TREE PROTECTION DETAIL.
- WHEN A LOW HANGING LIMB IS BROKEN DURING THE COURSE OF CONSTRUCTION, THE CONTRACTOR SHALL NOTIFY THE OWNER'S AUTHORIZED REPRESENTATIVE IMMEDIATELY. UNDER NO CIRCUMSTANCE SHALL THE CONTRACTOR PRUNE ANY PORTION OF THE DAMAGED TREE WITHOUT THE PRIOR APPROVAL BY THE OWNER'S AUTHORIZED REPRESENTATIVE.

EXISTING TREE LEGEND

- EXISTING TREE TO REMAIN
- EXISTING TREE TO BE REMOVED
- EXISTING SHRUB TO REMAIN
- EXISTING SHRUB TO BE REMOVED
- TREE PROTECTION FENCING TO REMAIN DURING CONSTRUCTION REFER TO 01/L.01

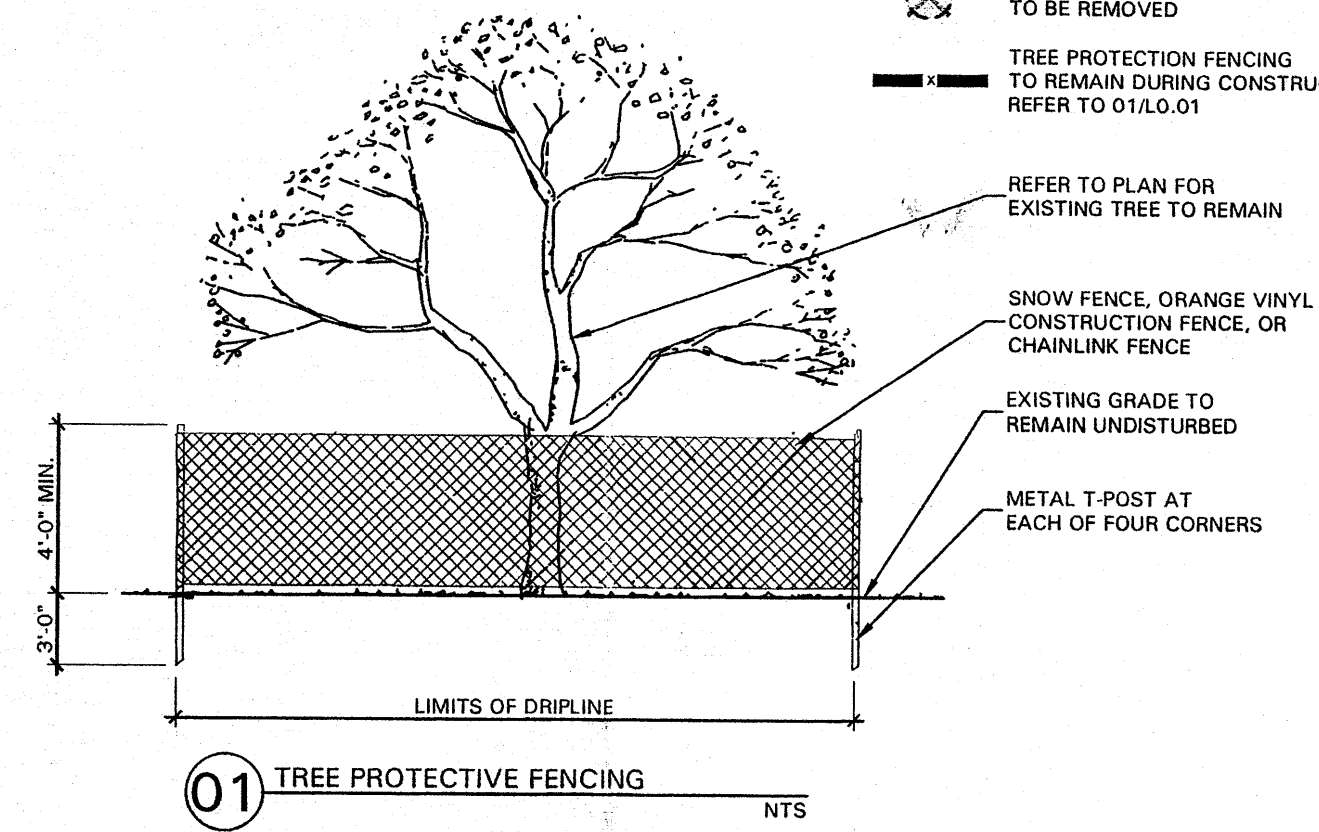

01 TREE PROTECTIVE FENCING NTS

ARCHITECT:
DAVID SCOTT WINDLE, AIA
1431 GREENWAY DRIVE
SUITE 150
IRVING, TX 75038
PHONE 972.870.1288
E-MAIL: scottw@dstudio04.com

CLIENT:
CHEDDAR'S CASUAL CAFE
2250 W. JOHN CARPENTER FWY, SUITE 560
IRVING, TX 75063
EMAIL: www.cheddars.com



CHEDDAR'S CASUAL CAFE
4865 PAN AMERICAN WEST FWY NE
ALBUQUERQUE, NM
CLIENT: CHEDDAR'S CASUAL CAFE

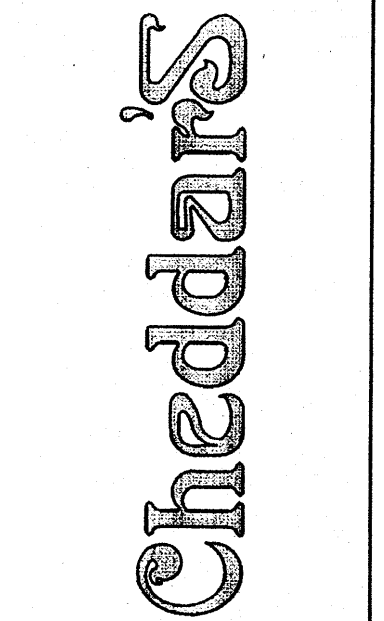

DATE	DESCRIPTION
12.20.20	ISSUE FOR PERMITS
02.05.21	CITY COMMENTS
02.10.21	CITY COMMENTS

DATE	DESCRIPTION

TREE PRESERVATION PLAN

L0.01

PROJECT NUMBER
CCC12012

LANDSCAPE ARCHITECT:
KORIAN HAUG, AIA, CLARB
4245 N. Central Expwy
Suite 230
Dallas, Texas 75205
214.865.7192

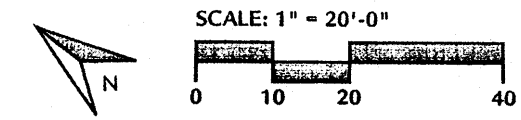

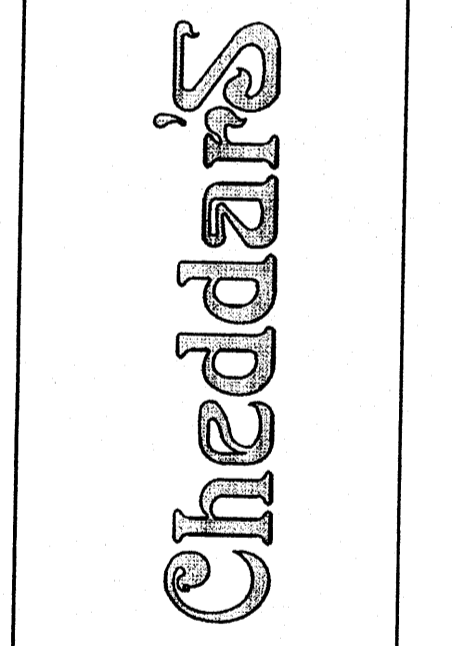
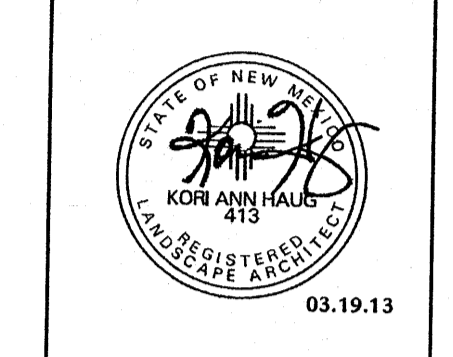

DATE	DESCRIPTION
12/10/12	ISSUE FOR PERMIT
08/20/12	CFR COMMENTS
08/20/12	CFR COMMENTS

DATE	DESCRIPTION

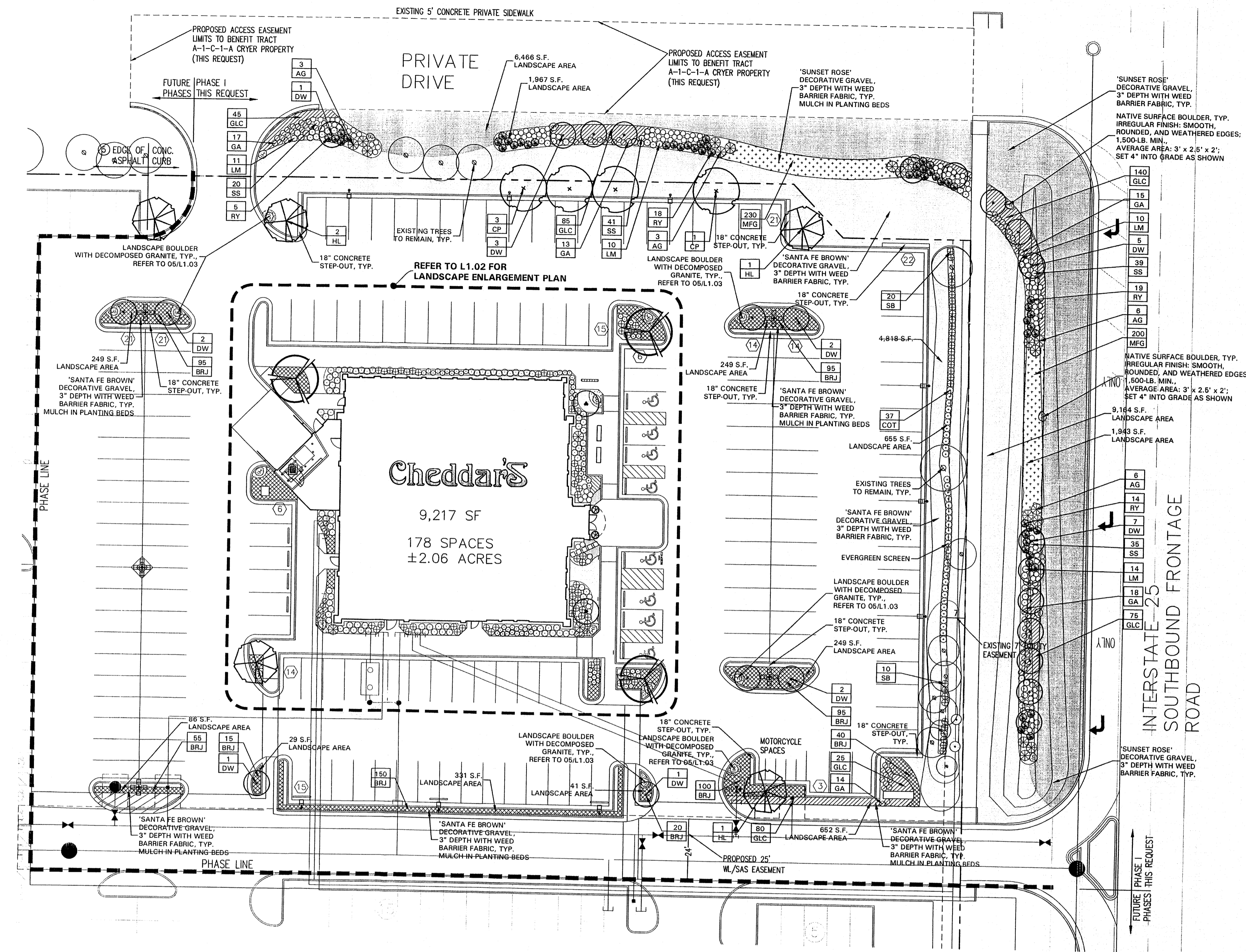

LANDSCAPE NOTES

- CONTRACTOR SHALL VERIFY ALL EXISTING AND PROPOSED SITE ELEMENTS AND NOTIFY LANDSCAPE ARCHITECT OF ANY DISCREPANCIES. SURVEY DATA OF EXISTING CONDITIONS WAS SUPPLIED BY OTHERS.
- CONTRACTOR SHALL LOCATE ALL EXISTING UNDERGROUND UTILITIES AND NOTIFY LANDSCAPE ARCHITECT OF ANY CONFLICTS. CONTRACTOR SHALL EXERCISE CAUTION WHEN WORKING IN THE VICINITY OF UNDERGROUND UTILITIES.
- CONTRACTOR SHALL PROVIDE A MINIMUM 2% SLOPE AWAY FROM ALL STRUCTURES.
- CONTRACTOR SHALL FINE GRADE AREAS TO ACHIEVE FINAL CONTOURS AS INDICATED. LEAVE AREAS TO RECEIVE TOPSOIL 3" BELOW FINAL FINISHED GRADE IN PLANTING AREAS, AND 1" BELOW FINAL FINISHED GRADE IN LAWN AREAS.
- ALL PLANTING BEDS AND LAWN AREAS SHALL BE SEPARATED BY STEEL EDGING. NO STEEL EDGING SHALL BE INSTALLED ADJACENT TO BUILDINGS, WALLS, OR CURBS. CUT STEEL EDGING AT 45 DEGREE ANGLE WHERE IT INTERSECTS WALKS AND CURBS.
- TOP OF MULCH SHALL BE 1/2" MINIMUM BELOW THE TOP OF WALKS AND CURBS.
- ALL LANDSCAPE AREAS SHALL BE PROVIDED WITH AN AUTOMATIC UNDERGROUND IRRIGATION SYSTEM WITH RAIN AND FREEZE SENSORS AND EVAPOTRANSPIRATION (ET) WEATHER-BASED CONTROLLERS AND SAID IRRIGATION SYSTEM SHALL BE DESIGNED BY A QUALIFIED PROFESSIONAL AND INSTALLED BY A LICENSED IRRIGATOR.
- CONTRACTOR SHALL PROVIDE BID PROPOSAL LISTING UNIT PRICES FOR ALL MATERIAL PROVIDED.
- CONTRACTOR SHALL BE RESPONSIBLE FOR OBTAINING ALL REQUIRED LANDSCAPE AND IRRIGATION PERMITS.

MAINTENANCE NOTES

- THE OWNER, TENANT AND THEIR AGENT, IF ANY, SHALL BE JOINTLY AND SEVERALLY RESPONSIBLE FOR THE MAINTENANCE OF ALL LANDSCAPE.
- ALL LANDSCAPE SHALL BE MAINTAINED IN A NEAT AND ORDERLY MANNER AT ALL TIMES. THIS SHALL INCLUDE MOWING, EDGING, PRUNING, FERTILIZING, WATERING, WEEDING AND OTHER SUCH ACTIVITIES COMMON TO LANDSCAPE MAINTENANCE.
- ALL LANDSCAPE AREAS SHALL BE KEPT FREE OF TRASH, LITTER, WEEDS AND OTHER SUCH MATERIAL OR PLANTS NOT PART OF THIS PLAN.
- ALL PLANT MATERIAL SHALL BE MAINTAINED IN A HEALTHY AND GROWING CONDITION AS IS APPROPRIATE FOR THE SEASON OF THE YEAR.
- ALL PLANT MATERIAL WHICH DIES SHALL BE REPLACED WITH PLANT MATERIAL OF EQUAL OR BETTER VALUE.
- CONTRACTOR SHALL PROVIDE SEPARATE BID PROPOSAL FOR ONE YEAR'S MAINTENANCE TO BEGIN AFTER FINAL ACCEPTANCE.

LANDSCAPE TABULATIONS

SITE LANDSCAPE

- 15% of the net lot area shall be landscape.
- A minimum of 75% of the required landscape area shall be live vegetative matter.

Lot Area = 99,734 s.f. (2.06 AC)
Building Area = 9,128 s.f.
Net Lot Area = 80,606 s.f.

Required	Provided
12,091 s.f. (15%)	29,862 s.f. (37%)
	10,322 s.f. (inside property line)
	19,540 s.f. (R.O.W.)
9,068 s.f. vegetative matter (75%)	9,171 s.f. vegetative matter (76%)
	5,261 s.f. (inside property line)
	3,910 s.f. (R.O.W.)

PARKING AREA LANDSCAPING (176 spaces)

- One (1) tree, 2" cal. min., per (10) parking spaces.
- No parking space may be more than 100' from the trunk of a tree trunk.

Required	Provided
(18) trees, 2" cal.	(19) trees, 2" cal. min.
Each parking space within 100' of a tree	Each parking space within 100' of a tree

PARKING SCREENING

- Where parking areas abut the public street and are greater than 100 ft. and the total parking amounts to 50 spaces or more, a 38" ht. max. screen is required.

Required	Provided
36" ht. screen	combination 24-30" ht. berm / evergreen screen

STREET TREES

- Where the lot is adjacent to a major street, major local street, or another street, street trees are required, with typical spacing of one (1) tree per 30 ft.

Required	Provided
(7) trees	(12) trees

Interstate 25 Frontage Road = 213 ft.

ALL EXISTING LANDSCAPE TO BE REMOVED AND REPLACED IN LOCATIONS INDICATED ON THIS PLAN EXCEPT WHERE NOTED TO REMAIN.

STATEMENT OF COMPLIANCE

- THE SITE PLAN SHALL BE CONSISTENT WITH THE GENERAL LANDSCAPING REGULATIONS (Article 14-16-3-10).
- ALL LANDSCAPE AND IRRIGATION SHALL COMPLY WITH THE CITY OF ALBUQUERQUE'S WATER CONSERVATION LANDSCAPING ORDINANCE (Article 6-1-1-1).
- THE PROPERTY OWNER IS RESPONSIBLE FOR ALL SIDEWALK AND LANDSCAPE MAINTENANCE IN THE ADJACENT PUBLIC RIGHT-OF-WAY.
- ALL LANDSCAPE IMPROVEMENTS IN THE NMDOT RIGHT-OF-WAY AND ALL LANDSCAPING SHOWN ON THE APPROVED PLAN MUST BE MAINTAINED IN LIVING CONDITION.

PLANT LIST

SYMBOL	BOTANICAL NAME	COMMON NAME	QTY.	SIZE	REMARKS
TREES					
CT	<i>Chrysopsis catalpa</i>	Chitalpa	3	2" cal.	B&B or container grown, 10" ht., 4' spread, 4' branching ht., matching
DW	<i>Chrysopsis linearis</i>	Desert Willow	24	2" cal.	B&B or container grown, 8" ht., 4' spread, 3 trunk min., matching
HL	<i>Gleditsia triacanthos 'Shademaster'</i>	Shademaster Honey Locust	5	3" cal.	mature height of 20' and spread of 25'
CP	<i>Pistacia chinensis</i>	Chinese Pistache	4	3" cal.	mature height of 40' and spread of 40'
VT	<i>Vitex agnus-castus</i>	Vitex	2	2" cal.	mature height of 30' and spread of 25'
SHRUBS/GROUND COVER					
AG	<i>Agave parryi</i>	Parry's Agave	21	15 gal.	container full, 48" o.c.
BRJ	<i>Juniperus chinensis 'Blue Point'</i>	Blue Point Juniper	2	30" ht.	container full, 20" spread
BRJ	<i>Juniperus horizontalis 'Witoni'</i>	Blue Rug Juniper	885	1 gal.	container full, 12" spread, 18" o.c.
COT	<i>Cotoneaster glaucophyllus</i>	Grey Cotoneaster	37	5 gal.	container full, 20" spread, 24" o.c.
GLC	<i>Santolina chinensis 'Santolina'</i>	Gray Lavender Cotton	475	1 gal.	container full, 18" o.c., selection by Owner
DHG	<i>Pennisetum alopecuroides 'Hameln'</i>	Dwarf Hameln Grass	9	5 gal.	container full, 20" spread, 24" o.c.
RS	<i>Parosetta atriplicifolia</i>	Russian Sage	57	7 gal.	container full, 20" spread, 24" o.c.
GA	<i>Abutilon grandiflora</i>	Glossy Abutilon	91	5 gal.	container full, 20" spread, 24" o.c.
LM	<i>Muhlenbergia inodora</i>	Lindheimer's Muhly	128	5 gal.	container full, 30" o.c.
MFG	<i>Hesperaloe parviflora</i>	Mexican Feathergrass	430	1 gal.	container full, 18" o.c.
RY	<i>Cyperus scoparius</i>	Red Yucca	56	7 gal.	container full, 30" o.c.
SB	<i>Cyperus scoparius</i>	Scotch Broom	95	5 gal.	container full, 30" o.c.
SC	<i>Arenaria lilifolia</i>	Seasonal Color	45	4" pots	container full, 12" o.c., selection by Owner
SS	<i>Arenaria lilifolia</i>	Sand Sage	149	5 gal.	container full, 20" spread, 24" o.c.

NOTE: ALL TREES SHALL HAVE STRAIGHT TRUNKS AND BE MATCHING WITHIN VARIETIES.
PLANT LIST IS AN AID TO BIDDERS ONLY. CONTRACTOR SHALL VERIFY ALL QUANTITIES ON PLAN.
ALL HEIGHTS AND SPREADS ARE MINIMUMS. ALL PLANT MATERIAL SHALL MEET OR EXCEED REMARKS AS INDICATED.

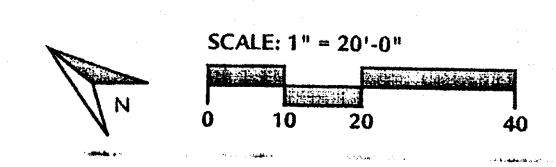

LANDSCAPE ARCHITECT:
KORI ANN HAIDT, AIA, CLARB
4245 N. Central Expwy
Suite 230
Dallas, Texas 75205
214.865.7192

ARCHITECT:

DAVID SCOTT WINDLE, AIA

1431 GREENWAY DRIVE SUITE 150 IRVING, TX 75038 PHONE 972.870.1288 E-MAIL: scottw@dstudio4.com

DATE:

CHEDDARS CASUAL CAFE 2250 W. JOHN CARPENTER FWY, SUITE 560 IRVING, TX 75063 EMAIL: www.cheddars.com



CHEDDARS CASUAL CAFE

4865 PAN AMERICAN WEST FWY NE ALBUQUERQUE, NM CLIENT: CHEDDARS CASUAL CAFE



DATE	DESCRIPTION
12/20/12	ISSUE FOR PERMIT
08/20/13	CITY COMMENTS
03/19/13	CITY COMMENTS

DATE	DESCRIPTION

LANDSCAPE ENLARGEMENT PLAN

L1.02

PROJECT NUMBER CCC12012

LANDSCAPE ARCHITECT: KORI HAUG, ASLA, QARB 4245 N. Central Expy Suite 230 Dallas, Texas 75205 214.865.7192

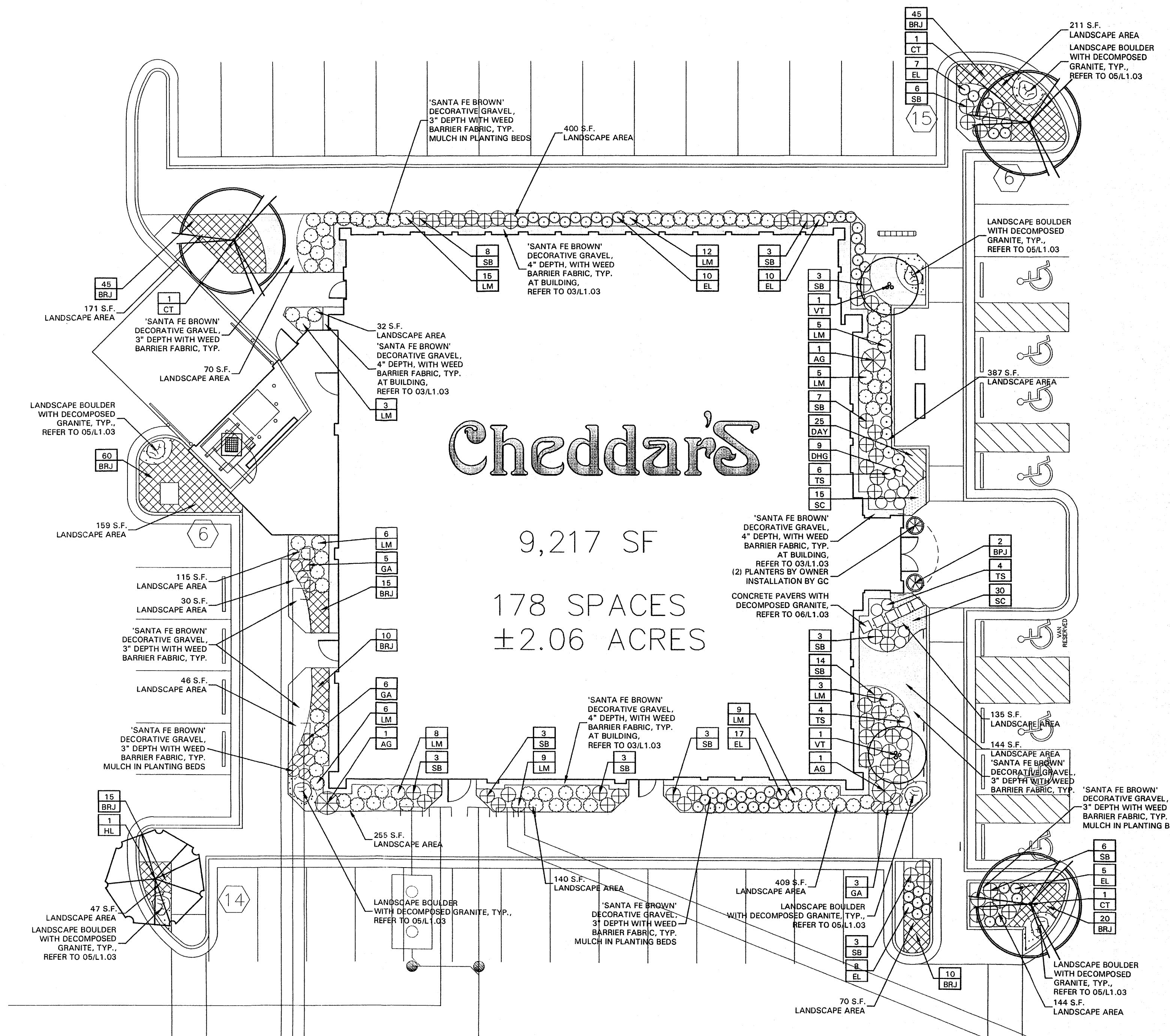

PLANT LEGEND

SYMBOL	COMMON NAME
CT	Chitalpa
DW	Desert Willow
HL	Shademaster Honey Locust
CP	Chinese Pistache
VT	Vitex
AG	Parry's Agave
BPJ	Blue Point Juniper
BRJ	Blue Rug Juniper
COI	Gray Cottonaster
GLC	Gray Lavender Cotton
DHG	Dwarf Hamden Grass
RS	Russian Sage
GA	Glossy Abelia
LM	Lindheimer's Muhly
MFG	Mexican Feathergrass
RY	Red Yucca
SB	Scotch Broom
SC	Seasonal Color
SS	Sand Sage

REFER TO L1.01 FOR PLANT LIST

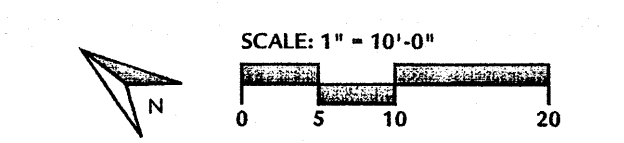

SECTION 32 9300 - LANDSCAPE

PART 1 - GENERAL

1.1 REFERENCED DOCUMENTS

- A. Refer to Landscape Plans, notes, details, bidding requirements, special provisions, and schedules for additional requirements.

1.2 DESCRIPTION OF WORK

- A. Work included: Furnish all supervision, labor, materials, services, equipment and appliances required to complete the work covered in conjunction with the landscaping covered in these specifications and landscaping plans, including:
 - Planting (trees, shrubs and grasses)
 - Bed preparation and fertilization
 - Notification of sources
 - Water and maintenance until final acceptance
 - Guarantee

1.3 REFERENCE STANDARDS

- A. American Standard for Nursery Stock published by American Association of Nurserymen: 27 October 1980, Edition; by American National Standards Institute, Inc. (Z60.1) - plant material
- B. American Joint Committee on Horticultural Nomenclature: 1942 Edition of Standardized Plant Names.
- C. New Mexico Association of Nurserymen, Grades and Standards
- D. Hortis Third, 1976 - Cornell University

1.4 NOTIFICATION OF SOURCES AND SUBMITTALS

- A. Samples: Provide representative quantities of sandy loam soil, mulch, bed mix material, gravel and crushed stone. Samples shall be approved by Owner's Authorized Representative before use on the project.

1.5 JOB CONDITIONS

- A. General Contractor to complete the following punch list: Prior to Landscape Contractor initiating any portion of landscape installation, General Contractor shall leave planting bed areas three (3) inches below final finish grade of sidewalks, drives and curbs as shown on the drawings. All lawn areas to receive solid sod shall be left one (1") inch below the final finish grade of sidewalks, drives and curbs. All construction debris shall be removed prior to Landscape Contractor beginning any work.
- B. Storage of materials and equipment at the job site will be at the risk of the Landscape Contractor. The Owner cannot be held responsible for theft or damage.

1.6 MAINTENANCE AND GUARANTEE

- A. Maintenance:
 - The Landscape Contractor shall be held responsible for the maintenance of all work from the time of planting until final acceptance by the Owner. No trees, shrubs, groundcover or grass will be accepted unless they show healthy growth and satisfactory foliage conditions.
 - Maintenance shall include watering of trees and plants; cultivation, weeding, spraying, edging, pruning of trees, mowing of grass, cleaning up and all other work necessary of maintenance.
 - A written notice requesting final inspection and acceptance should be submitted to the Owner at least seven (7) days prior to completion. An on-site inspection by the Owner's Authorized Representative will be completed prior to written acceptance.
- B. Guarantee:

- 1. Trees, shrubs and groundcover shall be guaranteed for a twelve (12) month period after final acceptance. The Contractor shall replace all dead materials as soon as weather permits and upon notification of the Owner. Plants, including trees, which have partially died so that shape, size, or symmetry have been damaged, shall be considered subject to replacement. In such cases, the opinion of the Owner shall be final.
 - Plants used for replacement shall be of the same size and kind as those originally planted and shall be planted as originally specified. All work, including materials, labor and equipment used in replacements, shall carry a twelve (12) month guarantee. Any damage, including roots in lawn or bed areas, incurred as a result of making replacements, shall be immediately repaired.
 - At the direction of the Owner, plants may be replaced at the start of the next year's planting season. In such cases, dead plants shall be removed from the premises immediately.
 - When plant replacements are made, plants, soil mix, fertilizer and mulch are to be utilized as originally specified and re-inspected for full compliance with the contract requirements. All replacements are to be included under "Work" of this section.
- 2. The Owner agrees that for the guarantee to be effective, he will water plants at least twice a week during dry periods and cultivate beds once a month after final acceptance.
- 3. The above guarantee shall not apply where plants die after acceptance because of injury from storms, hail, freezes, insects, diseases, injury by humans, machines or theft.
- 4. Acceptance for all landscape work shall be given after final inspection by the Owner provided the job is in a complete, undamaged condition and there is a stand of grass in all lawn areas. At that time, the Owner will assume maintenance on the accepted work.

1.7 QUALITY ASSURANCE

- A. General: Comply with applicable federal, state, county and local regulations governing landscape materials and work.
- B. Personnel: Employ only experienced personnel who are familiar with the required work. Provide full time supervision by a qualified foreman acceptable to Landscape Architect.
- C. Selection of Plant Material:
 - Make contact with suppliers immediately upon obtaining notice of contract acceptance to select and book materials. Develop a program of maintenance (pruning and fertilization) which will ensure the purchased materials will meet and / or exceed project specifications.
 - Substitutions: Do not make plant material substitutions. If the specified landscape material is not obtainable, submit proof of non-availability to Landscape Architect, together with proposal for use of equivalent material. At the time bids are submitted, the Contractor is assumed to have located the materials necessary to complete the job as specified.
 - Landscape Architect will provide a key identifying each tree location on site. Written verification will be required to document material selection, source and delivery schedules to site.
 - Measurements: Measure trees with branches and trunks or canes in their normal position. Do not prune to obtain required sizes. Take caliper measurements six inches above ground for trees up to and including 4" caliper size, and twelve inches above ground for larger sizes. Measure main body of all plant material of height and spread dimensions.

do not measure from branch or root tip to tip.

1.8 PRODUCT DELIVERY, STORAGE AND HANDLING

- A. Preparation:
 - Balled and Burlapped (B&B) Plants: Dig and prepare shipment in a manner that will not damage roots, branches, shape and future development.
 - Container Grown Plants: Deliver plants in rigid container to hold ball shape and protect root mass.
- B. Delivery:
 - Deliver packaged materials in sealed containers showing weight, analysis and name of manufacturer. Protect materials from deterioration during delivery and while stored on job site.
 - Deliver only plant materials that can be planted in one day unless adequate storage and watering facilities are available on job site.
 - Protect root balls by heeling in with sawdust or other approved moisture retaining material if not planted within 24 hours of delivery.
 - Protect plants during delivery to prevent damage to root balls or decoloration of leaves. Keep plants moist at all times. Cover all materials during transport.
 - Notify Owner's Authorized Representative of delivery schedule 72 hours in advance job site.
 - Remove rejected plant material immediately from job site.
 - To avoid damage or stress, do not lift, move, adjust to plumb, or otherwise manipulate plants by trunk or stems.

PART 2 - PRODUCTS

2.1 PLANTS

- A. General: Well-formed No. 1, grade or better nursery grown stock. Listed plant heights are from tops of root balls to nominal tops of plants. Plant spread refers to nominal outer width of the plant, not to the outer leaf tips. Plants will be individually approved by the Owner's Authorized Representative and his decision as to their acceptability shall be final.
- B. Quantities: The drawings and specifications are complimentary. Anything called for on one and not the other is as binding as if shown and called for on both. The plant schedule is an aid to bidders only. Confirm all quantities on plan.
- C. Quality and size: Plant materials shall conform to the size given on the plan, and shall be healthy, symmetrical, well-shaped, full branched and well rooted. The plants shall be free from injuries, insects, diseases, injuries to the bark or roots, broken branches, objectionable deformations, insect eggs and larvae, and are to be of specimen quality.
- D. Approval: All plants which are found unsuitable in growth, or are in any unhealthy, badly shaped or undersized condition will be rejected by the Owner's Authorized Representative either before or after planting and shall be removed at the expense of the Landscape Contractor and replaced with acceptable plant as specified at no additional cost to the Owner.

specified at no additional cost to the Owner.

2.2 SOIL PREPARATION MATERIALS

- A. Sandy Loam:
 - Friable, fertile, dark, loamy soil, free of clay lumps, subsoil, stones and other extraneous material and reasonably free of weeds and foreign grasses. Loam containing Dallassgrass or Nutgrass shall be rejected.
 - Physical properties as follows:
 - Clay - between 7-27 percent
 - Silt - between 15-25 percent
 - Sand - less than 52 percent
 - Organic matter shall be 3%-10% of total dry weight.
- B. Organic Matter: Compost with a mixture of 80% vegetative matter and 20% animal waste. Ingredients should be a mix of course and fine textured material.
- C. Sharp Sand: Sharp sand must be free of seeds, soil particles and weeds.
- D. Mulch: Double Shredded Hardwood Mulch, partially decomposed, dark brown.
- E. Organic Fertilizer: Fertiliad, Sustane, or Green Sense or equal as recommended for required applications. Fertilizer shall be delivered to the site in original unopened containers, each bearing the manufacturer's guaranteed statement of analysis.
- F. Commercial Fertilizer: 10-20-10 or similar analysis. Nitrogen source to be a minimum 50% slow release organic Nitrogen (SCU or LF) with a minimum 8% sulfur and 4% iron, plus micronutrients.
- G. Peat: Commercial sphagnum peat moss or partially decomposed shredded pine bark or other approved organic material.

2.3 MISCELLANEOUS MATERIALS

- A. Steel Edging: 3/16" x 4" x 1/8" black, DURAEDEGE® steel landscape edging manufactured by The J.D. Russell Company under its trade name DURAEDEGE Heavy Duty Steel.
- B. Staking Material for Shade Trees: refer to details.
- C. Gravel: Washed native pea gravel, graded 1 inch to 1-1/2 inch.
- D. Filter Fabric: "Mirafi Mirascape" by Mirafi Construction Products or approved equal.

PART 3 - EXECUTION

3.1 BED PREPARATION & FERTILIZATION

- A. Landscape Contractor to inspect all existing conditions and report any deficiencies to the Owner.
- B. All planting areas shall be conditioned as follows:

- 1. Prepare new planting beds by scraping away existing grass and weeds as necessary. Till existing soil to a depth of six (6") inches prior to placing compost and fertilizer. Apply fertilizer as per Manufacturer's recommendations. Add six (6") inches of compost and till into a depth of six (6") inches of the topsoil. Apply organic fertilizer such as Sustane or Green Sense at the rate of twenty (20) pounds per one thousand (1,000) square feet.
- 2. All planting areas shall receive a two (2") inch layer of specified mulch.
- 3. Backfill for tree pits shall be as follows: Use existing top soil on site (use imported topsoil as needed) free from large clumps, rocks, debris, caliche, subsoils, etc., placed in nine (9") inch layers and watered in thoroughly.

3.2 INSTALLATION

- A. Maintenance of plant materials shall begin immediately after each plant is delivered to the site and shall continue until all construction has been satisfactorily accomplished.
- B. Plant materials shall be delivered to the site only after the beds are prepared and areas are ready for planting. All shipments of nursery materials shall be thoroughly protected from the drying winds during transit. All plants which cannot be planted at once, after delivery to the site, shall be well protected against the possibility of drying by wind and Balls of earth of B & B plants shall be kept covered with soil or other acceptable material. All plants remain the property of the Contractor until final acceptance.
- C. Position the trees and shrubs in their intended location as per plan.
- D. Notify the Owner's Authorized Representative for inspection and approval of all positioning of plant materials.
- E. Excavate pits with vertical sides and horizontal bottom. Tree pits shall be large enough to permit handling and planting without injury to balls of earth or roots and shall be of such depth that, when planted and settled, the crown of the plant shall bear the same relationship to the finish grade as it did to soil surface in original place of growth.
- F. Shrub and tree pits shall be no less than twenty-four (24") inches wider than the lateral dimension of the earth ball and six (6") inches deeper than it's vertical dimension. Remove and haul from site all rocks and stones over three-quarter (3/4") inch in diameter. Plants should be thoroughly moist before removing containers.
- G. Dig a wide, rough sided hole exactly the same depth as the height of the ball, especially at the surface of the ground. The sides of the hole should be rough and jagged, never slick or glazed.
- H. Percolation Test: Fill the hole with water. If the water level does not percolate within 24 hours, the tree needs to move to another location or have drainage added. Install a PVC stand pipe per tree planting detail as approved by the Landscape Architect if the percolation test fails.
- I. Backfill only with 5 parts existing soil or sandy loam and 1 part bed preparation. When the hole is dug in solid rock, topsoil from the same area should not be used. Carefully settle by watering the ball, as well as all nylon, plastic string and wire. Container trees will usually be root bound, if so follow standard nursery practice of "root scoring".
- J. Do not wrap trees.
- K. Do not over prune.

- L. Mulch the top of the ball. Do not plant grass all the way to the trunk of the tree. Leave the area above the top of the ball and mulch with at least two (2") inches of specified mulch.
- M. All plant beds and trees to be mulched with a minimum settled thickness of two (2") inches over the entire bed or pit.
- N. Obstruction below ground: In the event that rock, or underground construction work or obstructions are encountered in any plant pit excavation work to be done under this section, alternate locations may be selected by the Owner. Where locations cannot be changed, the obstructions shall be removed to a depth of not less than three (3') feet below grade and no less than six (6") inches below the bottom of ball when plant is properly set at the required grade. The work of this section shall include the removal from the site of such rock or underground obstructions encountered at the cost of the Landscape Contractor.
- O. Trees and large shrubs shall be staked as site conditions require. Position stakes to secure trees against seasonal prevailing winds.
- P. Pruning and Mulching: Pruning shall be directed by the Landscape Architect and shall be pruned in accordance with standard horticultural practices following Fine Pruning, Class I pruning standards provided by the National Arborist Association.

- 1. Dead wood, suckers, broken and badly bruised branches shall be removed. General tipping of the branches is not permitted. Do not cut terminal branches.
- 2. Pruning shall be done with clean, sharp tools.
- 3. Immediately after planting operations are completed, all tree pits shall be covered with a layer of organic material two (2") inches in depth. The limit of the organic material for trees shall be the diameter of the plant pit.

3.3 CLEANUP AND ACCEPTANCE

- A. Cleanup: During the work, the premises shall be kept neat and orderly at all times. Storage areas for all materials shall be so organized so that they, too, are neat and orderly. All trash and debris shall be removed from the site as work progresses. Keep paved areas clean by sweeping or hosing them at end of each work day.

END OF SECTION

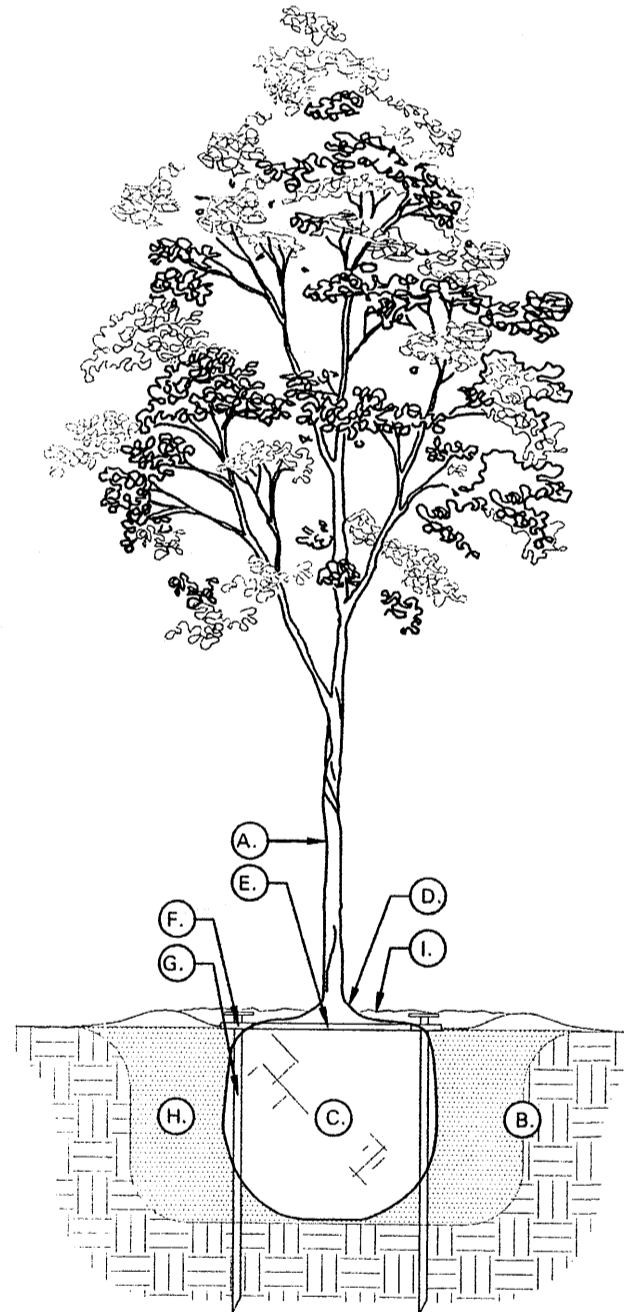

TREE PLANTING DETAIL LEGEND AND NOTES

- A. TREE: TREES SHALL CONFORM WITH LATEST AMERICAN STANDARD FOR NURSERY STOCK. www.asna.org
- B. TREE PIT: WIDTH TO BE AT LEAST TWO (2) TIMES THE DIAMETER OF THE ROOT BALL CENTER TRUNK IN HOLE & REST ROOT BALL ON UNDISTURBED NATIVE SOIL.
- C. ROOT BALL: REMOVE TOP 1/2 BURLAP AND ANY OTHER FOREIGN OBJECT; CONTAINER GROWN STOCK TO BE INSPECTED FOR GIRDLING ROOTS.
- D. ROOT FLARE: ENSURE THAT ROOT FLARE IS EXPOSED, FREE FROM MULCH, AND AT LEAST TWO INCHES ABOVE GRADE. TREES SHALL BE REJECTED WHEN GROUNDING ROOTS ARE PRESENT & ROOT FLARE IS NOT APPARENT.
- E. ROOTBALL ANCHOR RING: REFER TO MANUFACTURER'S GUIDELINES FOR SIZING. PLACE ROOTBALL ANCHOR RING ON BASE OF ROOTBALL. TRUNK SHOULD BE IN THE CENTER OF THE RING.
- F. 'U' BRACKET.
- G. 30" x 36" NAIL STAKE: INSTALL NAIL STAKE WITH HAMMER OR MALLET FIRMLY INTO UNDISTURBED GROUND. DRIVE NAIL STAKES FLUSH WITH 'U' BRACKET ADJACENT TO ROOTBALL (DO NOT DISTURB ROOTBALL).
- H. BACKFILL: USE EXISTING NATIVE SOIL (no amendments) WATER THOROUGHLY TO ELIMINATE AIR POCKETS.
- I. MULCH: DOUBLE SHREDDED HARDWOOD MULCH 2 INCH SETTLED THICKNESS, WITH 2" HT. WATERING RING; ENSURE THAT ROOT FLARE IS EXPOSED. BELOW GROUND STAKE SHOULD NOT BE VISIBLE.
- J. TREE STAKES: TREE STAKE SOLUTIONS 'SAFETY STAKE' BELOW GROUND MODEL AVAILABLE FROM: www.treestakesolutions.com (281) 723-9081
- K. IT SHALL BE THE RESPONSIBILITY OF THE CONTRACTOR TO OBTAIN A COPY OF THE MANUFACTURER'S SPECIFICATIONS PRIOR TO INSTALLATION OF TREE STAKES. CONTRACTOR SHALL ADHERE TO MANUFACTURER'S INSTALLATION GUIDELINES, SPECIFICATIONS, AND OTHER REQUIREMENTS FOR TREE STAKE INSTALLATION.

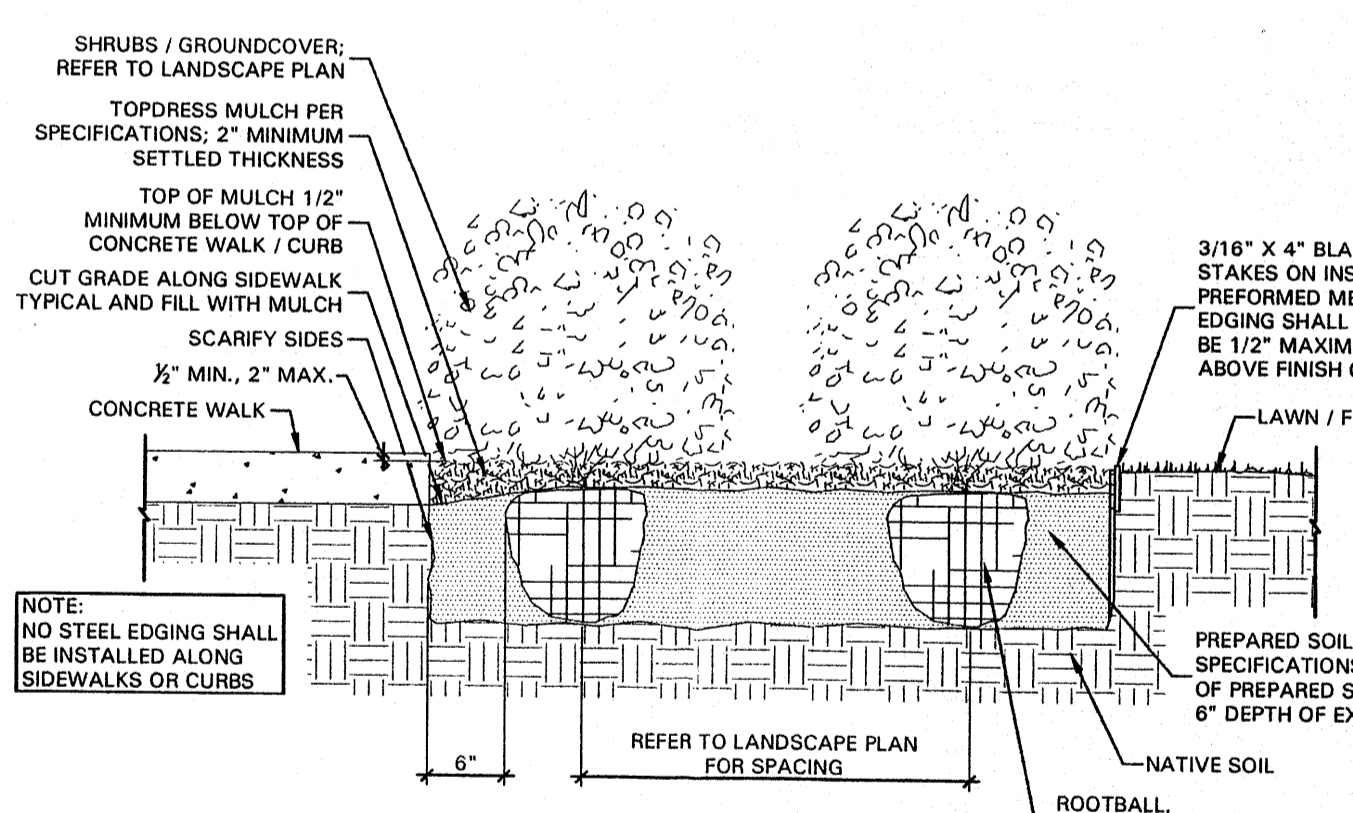

02 SHRUB / GROUND COVER DETAIL NOT TO SCALE

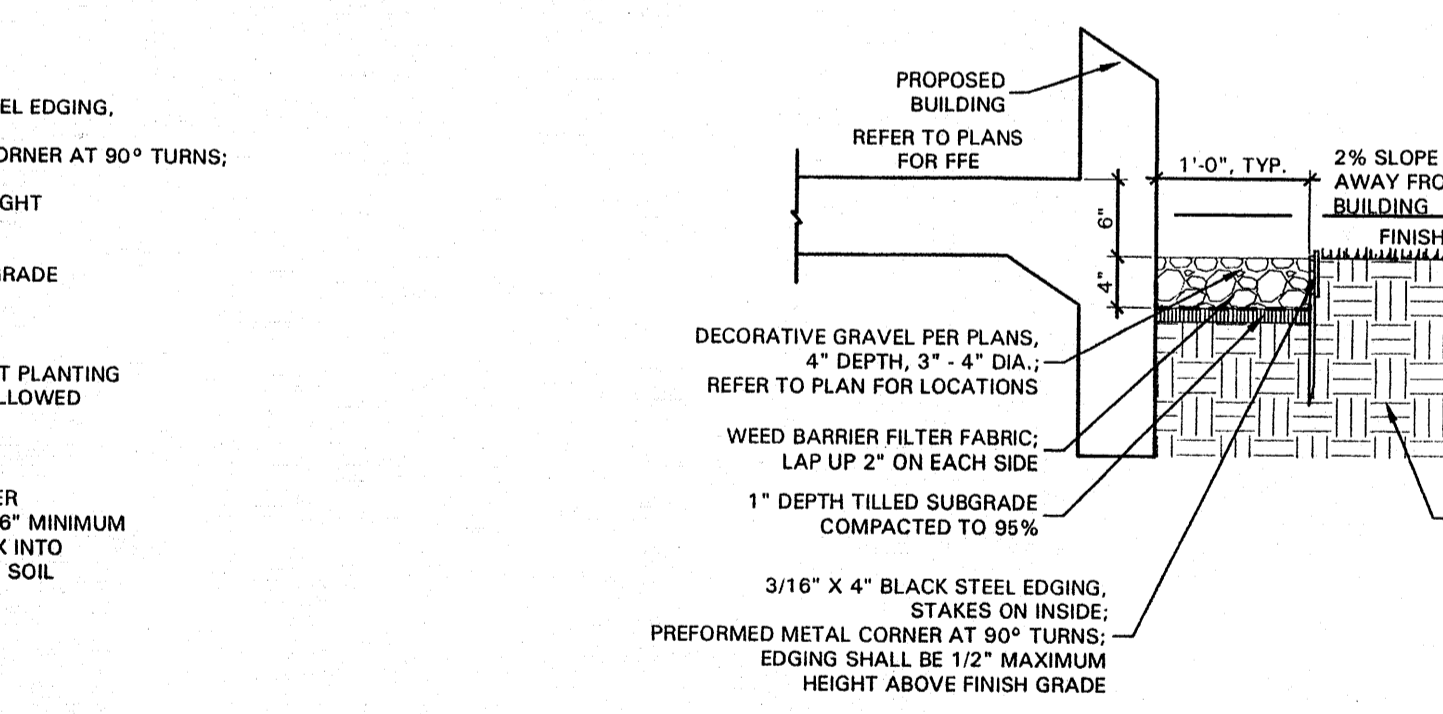

03 ROCK / GRAVEL BORDER AT BUILDING DETAIL SCALE: 1" = 1'-0"

01 TREE PLANTING DETAIL NOT TO SCALE

NOT USED

04 YARD INLET SCALE: 1" = 1'-0"

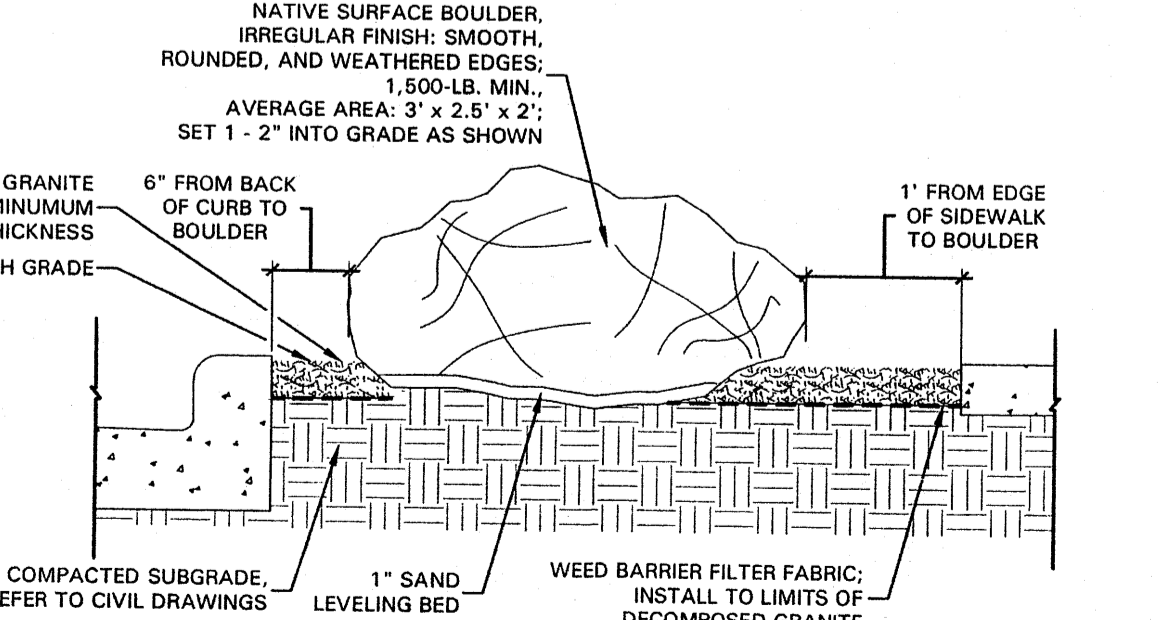

05 BOULDER DETAIL SCALE: 1" = 1'-0"

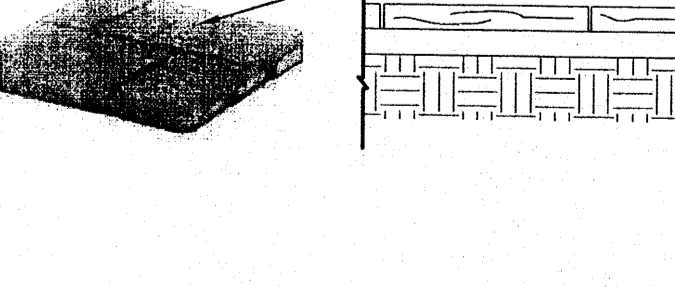

06 CONCRETE PAVER DETAIL SCALE: 1" = 1'-0"

ARCHITECT:
DAVID SCOTT WINDLE, AIA
1431 GREENWAY DRIVE
SUITE 150
IRVING, TX 75038
PHONE 972.870.1288
E-MAIL scottw@dstudio4.com

CLIENT:
CHEDDAR'S CASUAL CAFE
2250 W. JOHN CARPENTER FWY, SUITE 550
IRVING, TX 75038
EMAIL: www.cheddar.com

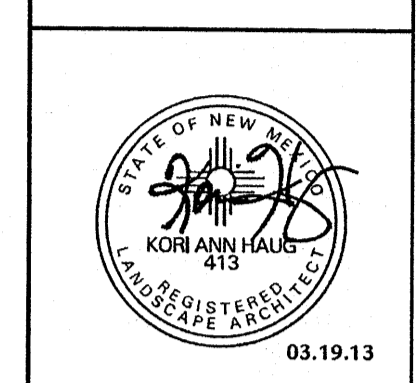

03.19.13

CHEDDAR'S CASUAL CAFE
4665 PAN-AMERICAN WEST FWY NE
ALBUQUERQUE, NM
CLIENT: CHEDDAR'S CASUAL CAFE

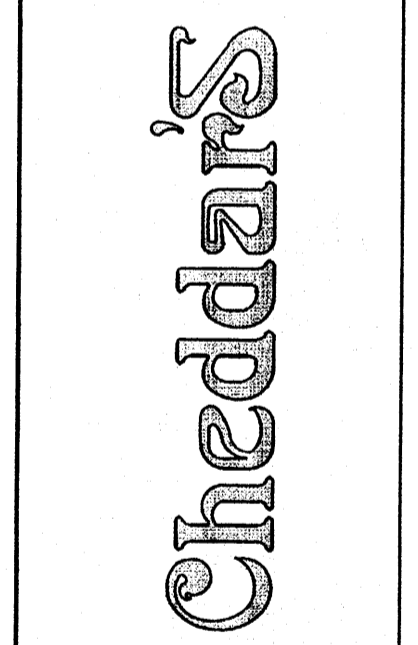

DATE	DESCRIPTION
03.19.13	ISSUE FOR PERMIT
03.19.13	CFE COMMENTS
03.19.13	CITY COMMENTS

LANDSCAPE SPECIFICATIONS AND DETAILS

L1.03

LANDSCAPE ARCHITECT:
KORI HAUG, ASIA, CLARB
4245 N. Central Expwy
Suite 230
Dallas, Texas 75205
214.865.7192

PROJECT NUMBER:
CCC12012

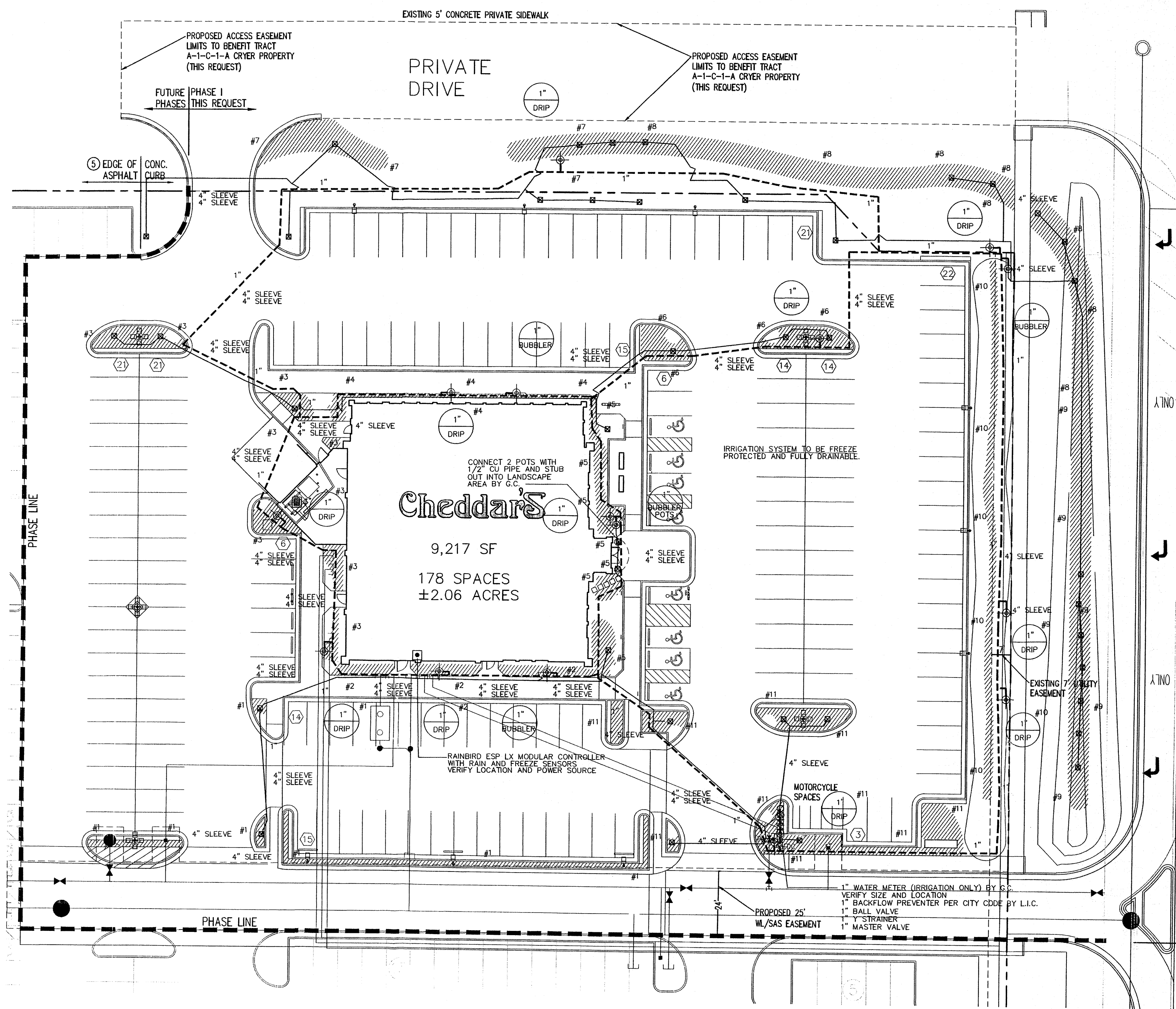

- SLEEVING NOTES**
- SLEEVES SHALL BE FURNISHED AND INSTALLED BY GENERAL CONTRACTOR.
 - SLEEVE MATERIAL SHALL BE SCHEDULE 40 PIPE, SIZE AS INDICATED ON PLAN.
 - CONTRACTOR SHALL LAY SLEEVES AND CONDUITS AT TWENTY-FOUR (24") INCHES BELOW FINISH GRADE OF THE TOP OF PAVEMENT.
 - CONTRACTOR SHALL EXTEND SLEEVES ONE (1') FOOT BEYOND EDGE OF ALL PAVEMENT.
 - CONTRACTOR SHALL CAP PIPE ENDS USING PVC CAPS.
 - CONTRACTOR SHALL FURNISH OWNER AND IRRIGATION CONTRACTOR WITH AN "AS-BUILT" DRAWING SHOWING ALL SLEEVE LOCATIONS.

- IRRIGATION NOTES**
- THE IRRIGATION CONTRACTOR SHALL COORDINATE INSTALLATION OF THE IRRIGATION SYSTEM WITH THE LANDSCAPE CONTRACTOR SO THAT ALL PLANT MATERIAL WILL BE WATERED IN ACCORDANCE WITH THE INTENT OF THE PLANS AND SPECIFICATIONS.
 - ALL SPRINKLER EQUIPMENT NUMBERS REFERENCE THE RAINBIRD EQUIPMENT CATALOG UNLESS OTHERWISE INDICATED.
 - TEN DAYS PRIOR TO START OF CONSTRUCTION, IRRIGATION CONTRACTOR SHALL VERIFY STATIC WATER PRESSURE. IF STATIC PRESSURE IS LESS THAN 65 P.S.I., NOTIFY THE LANDSCAPE ARCHITECT IMMEDIATELY. DO NOT WORK UNTIL NOTIFIED TO DO SO BY OWNER.
 - SLEEVES SHALL BE FURNISHED AND INSTALLED BY GENERAL CONTRACTOR. SLEEVE MATERIAL SHALL BE SCHEDULE 40, SIZE AS INDICATED ON PLAN. REFER TO SLEEVING NOTES.
 - ALL MAIN LINE AND LATERAL LINE PIPING IN PLANTING AND LAWN AREAS SHALL HAVE A MINIMUM OF 12 INCHES OF COVER. ALL PIPING UNDER PAVING SHALL HAVE A MINIMUM OF 18 INCHES OF COVER. CONTRACTOR TO VERIFY LOCAL FREEZE DEPTHS AND ADJUST DEPTH OF COVER ACCORDINGLY.
 - LAWN SPRAY HEADS SHALL BE RAINBIRD 1804 INSTALLED PER DETAIL SHOWN.
 - ROTOR HEADS SHALL BE RAINBIRD 5000 INSTALLED PER DETAIL SHOWN. (WITH BUILT-IN CHECK VALVE)
 - NOZZLES SHALL BE RAINBIRD PLASTIC. IRRIGATION CONTRACTOR SHALL SELECT THE PROPER ARC AND RADIUS FOR EACH NOZZLE TO ENSURE 100% AND PROPER COVERAGE OF ALL LAWN AREAS AND PLANT MATERIAL. NO WATER SHALL SPRAY ON BUILDING.
 - ALL NOZZLES IN PARKING LOT ISLANDS AND PLANTING BEDS SHALL BE LOW ANGLE NOZZLES TO MINIMIZE OVER SPRAY ON PAVEMENT SURFACES.
 - ELECTRIC CONTROL VALVES SHALL BE RAINBIRD PEB INSTALLED PER DETAIL SHOWN. SIZE OF VALVES AS SHOWN ON PLAN. VALVES SHALL BE INSTALLED IN VALVE BOXES LARGE ENOUGH TO PERMIT MANUAL OPERATION. REMOVAL OF SOLENOID AND / OR VALVE COVER WITHOUT ANY EARTH EXCAVATION.
 - ALL 24 VOLT VALVE WIRING TO BE UF 14 GAUGE SINGLE CONDUCTOR. ALL WIRE SPICES ARE TO BE PERMANENT AND WATERPROOF.
 - AUTOMATIC CONTROLLER SHALL BE INSTALLED AT LOCATION SHOWN. POWER (120V) SHALL BE LOCATED IN A JUNCTION BOX WITHIN FIVE (5') FEET OF CONTROLLER. LOCATION BY OTHER TRADES. RAIN AND FREEZE SENSORS SHALL BE INSTALLED WITH EACH CONTROLLER.
 - THE DESIGN PRESSURE IS 65 PSI.
 - ELECTRICAL SPICES AT EACH VALVE AND CONTROLLER ONLY.

IRRIGATION LEGEND

- RAINBIRD BUBBLER (2 PER TREE, TYP.)
- RAINBIRD PEB SERIES ELECTRIC VALVE
- CONTROLLER, SIZE AS INDICATED
- WATER METER, SIZE AS INDICATED WITH D.C.A., SIZE AS INDICATED
- PVC SCHEDULE 40 SLEEVING
- PVC CLASS 200 MAINLINE
- PVC CLASS 200 LATERAL LINE
- VALVE SIZE
- GPM
- NETAFIM TECHLINE #TLDL6-1210 (18" LATERAL SPACING, 12" EMITTER SPACING) PVC LATERAL PIPING SIZED AS REQUIRED. INSTALL ALL EQUIPMENT ACCORDING TO MANUFACTURERS SPECIFICATIONS
- NETAFIM DISC FILTER #DF100-080 NETAFIM PRESSURE REGULATOR #PRV15025. INSTALL ALL EQUIPMENT ACCORDING TO MANUFACTURERS SPECIFICATIONS

BUBBLER PIPING CHART

NUMBER OF BUBBLERS	SIZE OF PIPE
1 - 5	3/4"
6 - 10	1"
11 - 20	1 1/4"
21 - 30	1 1/2"
31 - 40	1 3/4"

ARCHITECT:
DAVID SCOTT WINDLE, AIA

1431 GREENWAY DRIVE
SUITE 150
IRVING, TX 75038
PHONE 972.870.1288
E-MAIL scottw@idsstudia.com

CLIENT:
CHEDDARS CASUAL CAFE
2250 W. JOHN CARPENTER FWY, SUITE 360
IRVING, TX 75063
EMAIL: www.cheddars.com

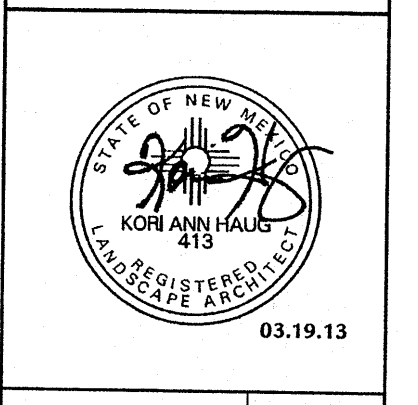

CHEDDARS CASUAL CAFE

4865 PAN AMERICAN WEST FWY NE
ALBUQUERQUE, NM

CLIENT: CHEDDARS CASUAL CAFE

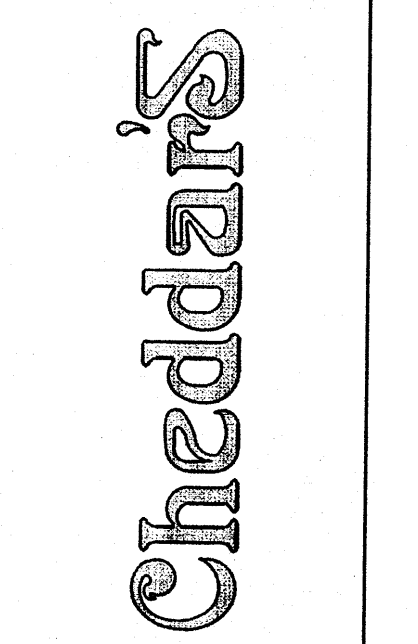

DATE	DESCRIPTION

DATE	DESCRIPTION

IRRIGATION PLAN

L2.01

PROJECT NUMBER
CCC12012

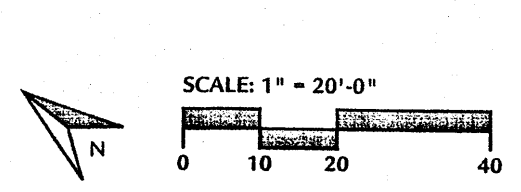

LANDSCAPE ARCHITECT:
KORI HAUG, ASLA, CLARB
4245 N. Central Expy
Suite 230
Dallas, Texas 75205
214.865.7192

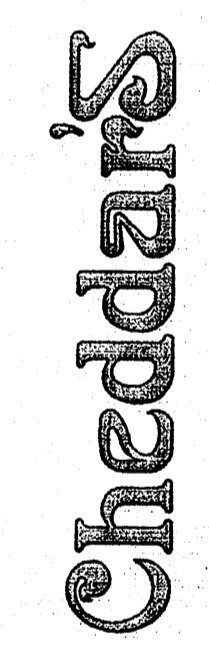
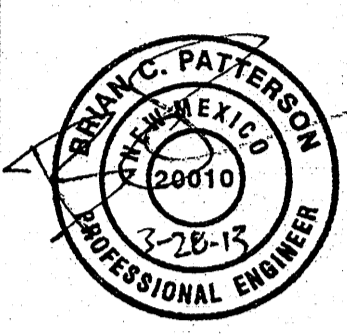

DATE	DESCRIPTION
12/20/12	ISSUE FOR PERMIT

DATE	DESCRIPTION
3/1/13	DRG COMMENTS

GRADING PLAN

GRADING KEYED NOTES

- (A) 2' WIDE CURB OPENING W/ WIRE MESH FENCE PER DETAIL THIS SHEET
- (B) PROPOSED INLET & 24" CULVERT
- (C) TEMPORARY INLET TO BE CLEANED AND MAINTAINED BY PROPERTY OWNER
- (D) DEPRESSED WATER HARVESTING AREA
- (E) NOT USED
- (F) PROPOSED 30" CULVERT
- (G) TEMPORARY DRAINAGE DIVERSION BEAM TO BE BUILT AND MAINTAINED UNTIL THIS AREA OF THE SITE DEVELOPS

GENERAL NOTES

1. ALL WORK DETAILED ON THESE PLANS AND PERFORMED UNDER THIS CONTRACT SHALL BE CONSTRUCTED IN ACCORDANCE WITH THE PROJECT SPECIFICATIONS AND THE PROJECT GEOTECHNICAL REPORT, WHERE APPLICABLE, CITY OF ALBUQUERQUE PUBLIC WORKS STANDARDS SHALL APPLY.
2. THE CONTRACTOR SHALL ABIDE BY ALL LOCAL, STATE, AND FEDERAL LAWS, RULES AND REGULATIONS WHICH APPLY TO THE CONSTRUCTION OF THESE IMPROVEMENTS, INCLUDING EPA REQUIREMENTS WITH RESPECT TO STORM WATER DISCHARGE.
3. PRIOR TO CONSTRUCTION, THE CONTRACTOR SHALL FIELD VERIFY THE HORIZONTAL AND VERTICAL LOCATIONS OF ALL POTENTIAL OBSTRUCTIONS INCLUDING ALL UNDERGROUND UTILITIES. SHOULD A CONFLICT EXIST, THE CONTRACTOR SHALL NOTIFY THE CONSTRUCTION OBSERVER OR ENGINEER SO THAT THE CONFLICT CAN BE RESOLVED WITH A MINIMUM AMOUNT OF DELAY.
4. TWO (2) WORKING DAYS PRIOR TO ANY EXCAVATION, THE CONTRACTOR SHALL CONTACT LINE LOCATING SERVICE FOR LOCATION OF EXISTING UTILITIES.
5. ALL ELECTRICAL, TELEPHONE, CABLE TV, GAS AND OTHER UTILITY LINES, CABLES, AND APPURTENANCES ENCOUNTERED DURING CONSTRUCTION THAT REQUIRE RELOCATION SHALL BE COORDINATED WITH THAT UTILITY. THE CONTRACTOR SHALL BE RESPONSIBLE FOR COORDINATION OF ALL NECESSARY UTILITY ADJUSTMENTS. NO ADDITIONAL COMPENSATION WILL BE ALLOWED FOR DELAYS OR INCONVENIENCES CAUSED BY UTILITY COMPANY WORK CREWS. THE CONTRACTOR MAY BE REQUIRED TO RESCHEDULE HIS ACTIVITIES TO ALLOW UTILITY CREWS TO PERFORM THEIR REQUIRED WORK.
6. THE CONTRACTOR IS RESPONSIBLE FOR PROTECTING ALL EXISTING UTILITY LINES WITHIN THE CONSTRUCTION AREA. ANY DAMAGE TO EXISTING FACILITIES CAUSED BY CONSTRUCTION ACTIVITY SHALL BE REPAIRED OR REPLACED AT THE CONTRACTOR'S EXPENSE AND APPROVED BY THE CONSTRUCTION OBSERVER.
7. CONSTRUCTION ACTIVITY SHALL BE LIMITED TO THE PROPERTY AND/OR PROJECT LIMITS. ANY DAMAGE TO ADJACENT PROPERTIES RESULTING FROM THE CONSTRUCTION PROCESS SHALL BE REPAIRED OR REPLACED AT THE CONTRACTOR'S EXPENSE.
8. OVERNIGHT PARKING OF CONSTRUCTION EQUIPMENT SHALL NOT OBSTRUCT DRIVEWAYS OR DESIGNATED TRAFFIC LANES. THE CONTRACTOR SHALL NOT STORE ANY EQUIPMENT OR MATERIAL WITHIN THE PUBLIC RIGHT-OF-WAY.
9. THE CONTRACTOR SHALL OBTAIN ALL THE NECESSARY PERMITS FOR THE PROJECT PRIOR TO COMMENCING CONSTRUCTION (I.E., BARRICADING, TOPSOIL DISTURBANCE, EXCAVATION PERMITS, EPA STORM WATER PERMITS, ETC.).
10. ALL PROPERTY CORNERS DESTROYED DURING CONSTRUCTION SHALL BE REPLACED AT THE CONTRACTOR'S EXPENSE. ALL PROPERTY CORNERS MUST BE RESET BY A REGISTERED LAND SURVEYOR.
11. THE CONTRACTOR SHALL PREPARE A CONSTRUCTION TRAFFIC CONTROL AND SIGNING PLAN AND OBTAIN APPROVAL OF SUCH PLAN FROM THE CITY OF ALBUQUERQUE TRAFFIC ENGINEERING DEPARTMENT, PRIOR TO BEGINNING ANY CONSTRUCTION WORK ON OR ADJACENT TO EXISTING STREETS.
12. ALL BARRICADES AND CONSTRUCTION SIGNING SHALL CONFORM TO APPLICABLE SECTIONS OF THE "MANUAL ON UNIFORM TRAFFIC CONTROL DEVICES" (MUTCD), US DEPARTMENT OF TRANSPORTATION, LATEST EDITION.
13. THE CONTRACTOR SHALL MAINTAIN ALL CONSTRUCTION BARRICADES AND SIGNING AT ALL TIMES. THE CONTRACTOR SHALL VERIFY THE PROPER LOCATION OF ALL BARRICADING AT THE END AND BEGINNING OF EACH DAY.
14. THE CONTRACTOR SHALL TAKE ALL STEPS NECESSARY TO CONFORM WITH EPA REQUIREMENTS, INCLUDING COMPLIANCE WITH NPDES PHASE 2 REQUIREMENTS.

GRADING NOTES

1. EXCEPT AS PROVIDED HEREIN, GRADING SHALL BE PERFORMED AT THE ELEVATIONS AND IN ACCORDANCE WITH THE DETAILS SHOWN ON THIS PLAN.
2. THE COST FOR REQUIRED CONSTRUCTION DUST AND EROSION CONTROL MEASURES SHALL BE INCIDENTAL TO THE PROJECT COST.
3. ALL WORK RELATIVE TO FOUNDATION CONSTRUCTION, SITE PREPARATION, AND PAVEMENT INSTALLATION, AS SHOWN ON THIS PLAN, SHALL BE CONSTRUCTED IN ACCORDANCE WITH THE "GEOTECHNICAL INVESTIGATION". ALL OTHER WORK SHALL, UNLESS OTHERWISE STATED OR PROVIDED FOR HEREON, BE CONSTRUCTED IN ACCORDANCE WITH THE PROJECT, (FIRST PRIORITY) SPECIFICATIONS, AND/OR THE CITY OF ALBUQUERQUE (COA) STANDARD SPECIFICATIONS FOR PUBLIC WORKS (SECOND PRIORITY).
4. EARTH SLOPES SHALL NOT EXCEED 3 HORIZONTAL TO 1 VERTICAL UNLESS SHOWN OTHERWISE.
5. IT IS THE INTENT OF THESE PLANS THAT THIS CONTRACTOR SHALL NOT PERFORM ANY WORK OUTSIDE OF THE PROPERTY BOUNDARIES EXCEPT AS REQUIRED BY THIS PLAN.
6. THE CONTRACTOR IS TO ENSURE THAT NO SOIL ERODES FROM THE SITE ONTO ADJACENT PROPERTY OR PUBLIC RIGHT-OF-WAY.
7. A DISPOSAL SITE FOR ANY & ALL EXCESS EXCAVATION MATERIAL, AND UNSUITABLE MATERIAL AND/OR A BORROW SITE CONTAINING ACCEPTABLE FILL MATERIAL SHALL BE OBTAINED BY THE CONTRACTOR IN COMPLIANCE WITH APPLICABLE ENVIRONMENTAL REGULATIONS AND APPROVED BY THE OBSERVER. ALL COSTS INCURRED IN OBTAINING A DISPOSAL OR BORROW SITE AND HAUL TO OR FROM SHALL BE CONSIDERED INCIDENTAL TO THE PROJECT AND NO SEPARATE MEASUREMENT OR PAYMENT SHALL BE MADE.
8. PAVING AND ROADWAY GRADES SHALL BE +/- 0.1' FROM PLAN ELEVATIONS. PAD ELEVATION SHALL BE +/- 0.05' FROM BUILDING PLAN ELEVATION.
9. ALL PROPOSED CONTOURS REFLECT TOP OF PAVEMENT ELEVATIONS IN THE PARKING AREA AND MUST BE ADJUSTED FOR MEDANS AND ISLANDS.
10. VERIFY ALL ELEVATIONS SHOWN ON PLAN FROM BASIS OF ELEVATION CONTROL STATION PRIOR TO BEGINNING CONSTRUCTION.
11. WATER HARVESTING SHOULD BE UTILIZED IN LANDSCAPE AREAS SUCH AS PARKING ISLANDS IN LOCATION FURTHER THAN 10' AWAY FROM BUILDING WHERE APPLICABLE.

- NOTES FOR WORK IN AMAFCA R/W OR EASEMENT
1. AMAFCA FIELD ENGINEER SHALL BE NOTIFIED 48 HOURS PRIOR TO ANY WORK WITHIN THE AMAFCA R/W AT 884-2215.
 2. NO WORK WILL BE PERFORMED IN THE AMAFCA R/W BETWEEN MAY 15 AND OCTOBER 15 WITHOUT WRITTEN PERMISSION FROM AMAFCA.
 3. ALL SUBGRADE, BACKFILL AND EMBANKMENT SHALL BE COMPACTED TO 95% (MODIFIED PROCTOR) WITHIN THE AMAFCA R/W. TESTING REPORTS SHALL BE PROVIDED TO AMAFCA FIELD ENGINEER.
 4. AMAFCA FIELD ENGINEER WILL BE NOTIFIED 48 HOURS PRIOR TO FINAL INSPECTION OF ANY FACILITIES WITHIN THE AMAFCA R/W.
 5. ALL DISTURBED GROUND AREAS SHALL BE REVEGETATED IN ACCORDANCE WITH CITY OF ALBUQUERQUE STANDARD SPECIFICATIONS FOR PUBLIC WORKS CONSTRUCTION, SECTION 1012 NATIVE GRASS SEEDING, AS CURRENTLY UPDATED.
 6. ANY EXISTING SURVEY CONTROL MONUMENTS THAT ARE MOVED OR DESTROYED AS A RESULT OF THE CONSTRUCTION SHALL BE REPLACED BY A LICENSED SURVEYOR AT THE OWNER'S EXPENSE.
 7. THE MAXIMUM WHEEL LOAD ALLOWED IN AMAFCA CHANNELS IS 12,000 POUNDS.
 8. NO TRACKED VEHICLES WILL BE ALLOWED IN AMAFCA CHANNELS WITHOUT WRITTEN PERMISSION FROM AMAFCA.
 9. OWNER'S CONTRACTOR SHALL CONTACT AMAFCA FOR A TEMPORARY CONSTRUCTION LICENSE PRIOR TO CONSTRUCTION.

APPROVED FOR CONSTRUCTION WITHIN AMAFCA RIGHT-OF-WAY / EASEMENT:

(FOR AMAFCA) _____ DATE _____

NOTE: AS A CONDITION OF APPROVAL FOR A PERMANENT CERTIFICATE OF OCCUPANCY, CERTIFIED AS-BUILT PLANS AND TESTING REPORTS MUST BE SUBMITTED TO AMAFCA FOR THE CONSTRUCTION WITHIN AMAFCA'S RIGHT-OF-WAY. THE CONTRACTOR WILL BE RESPONSIBLE TO RETAIN A SURVEYOR LICENSED IN NEW MEXICO TO OBTAIN AS-BUILT SURVEY DATA AND AN ENGINEER LICENSED IN NEW MEXICO TO PREPARE/CERTIFY AND SUBMIT THE AS-BUILT PLANS TO AMAFCA.

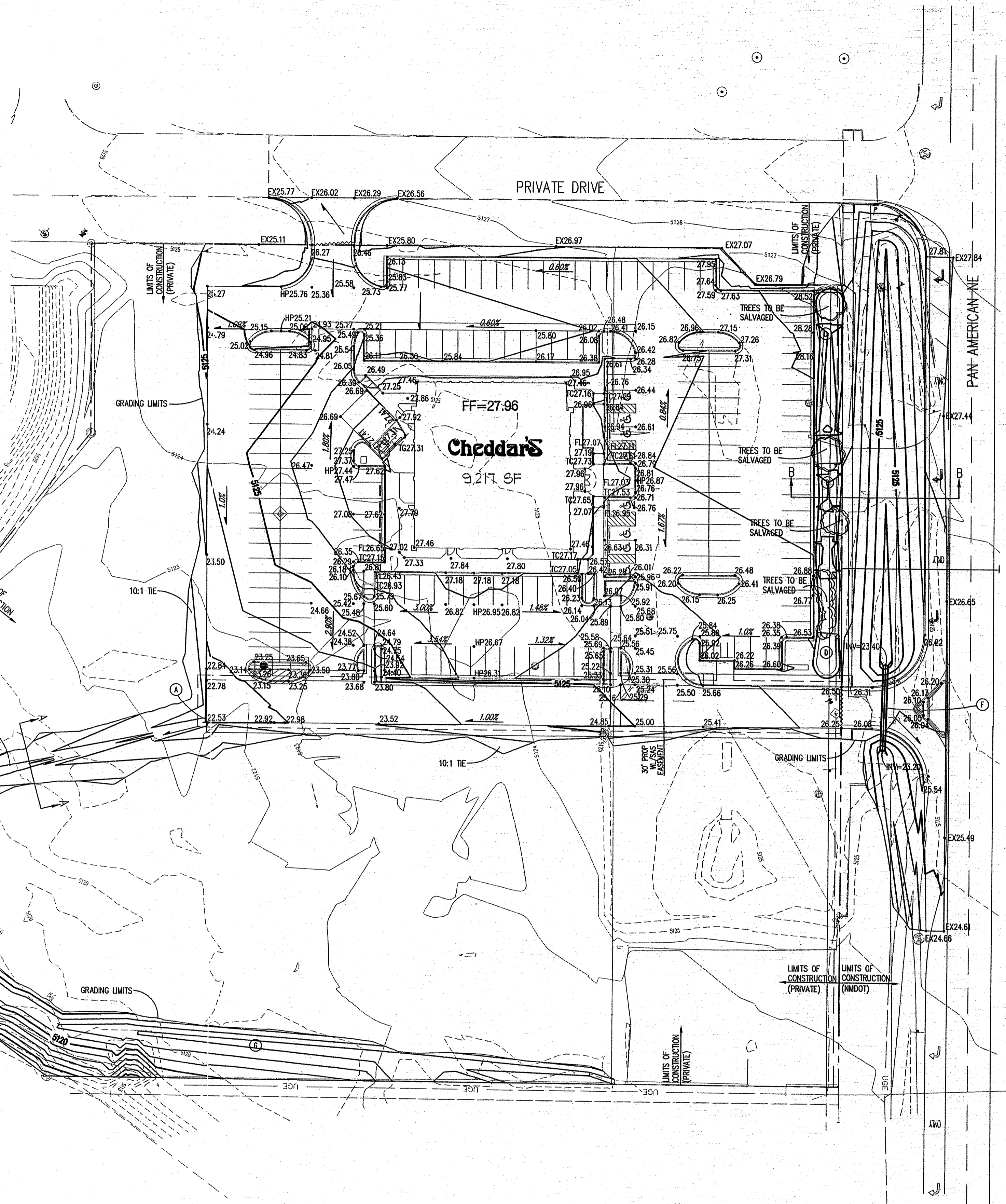

NOTE: WATER HARVESTING SHALL NOT BE CONSTRUCTED WITHIN DROP LINE OF TREES TO BE SALVAGED. SEE LOCATIONS OF TREES DEPICTED ON THIS SHEET AS WELL AS LANDSCAPE PLAN FOR TREES TO BE SALVAGED.

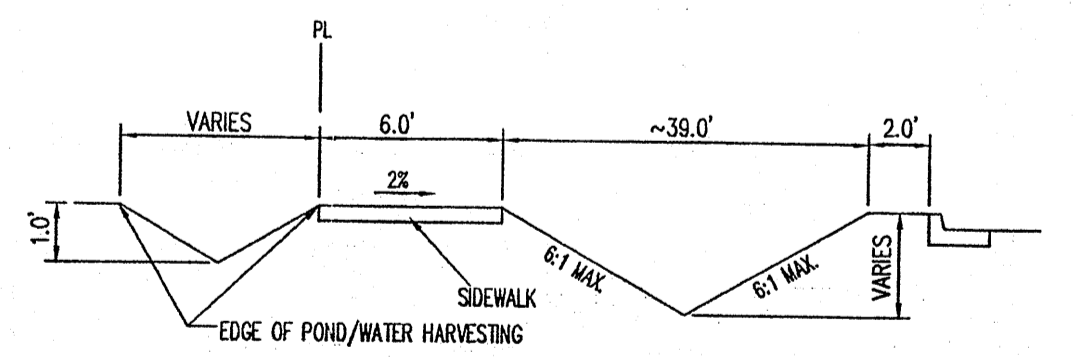

GRADING PLAN

- LEGEND**
- PROPERTY LINE
 - EXISTING CONTOURS
 - 65.23 PROPOSED SPOT ELEVATION
 - TO-TOP OF CURB, FL-FLOW LINE
 - TO-TOP OF WALL, FIN-BOTTOM OF WALL
 - EX-EXISTING, TO-TOP OF GRADE
 - PROPOSED DIRECTION OF FLOW
 - WATER BLOCK
 - 5.301 PROPOSED INDEX CONTOURS
 - 5.325 PROPOSED WATER CONTOURS
 - PROPOSED CURB & GUTTER
 - EASEMENT
 - ⊕ PROPOSED LIGHTING
 - PROPOSED STORM DRAIN LINE

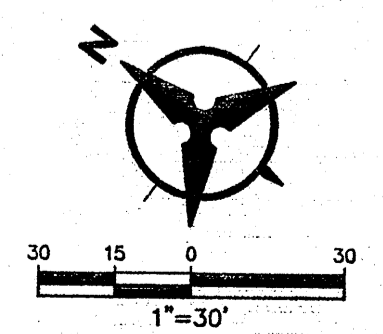
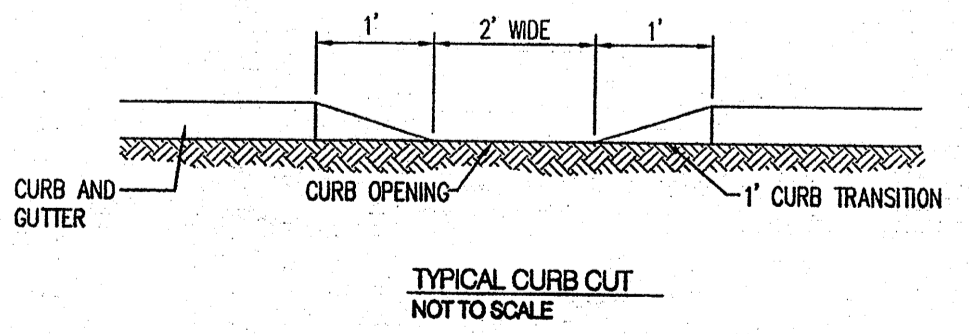
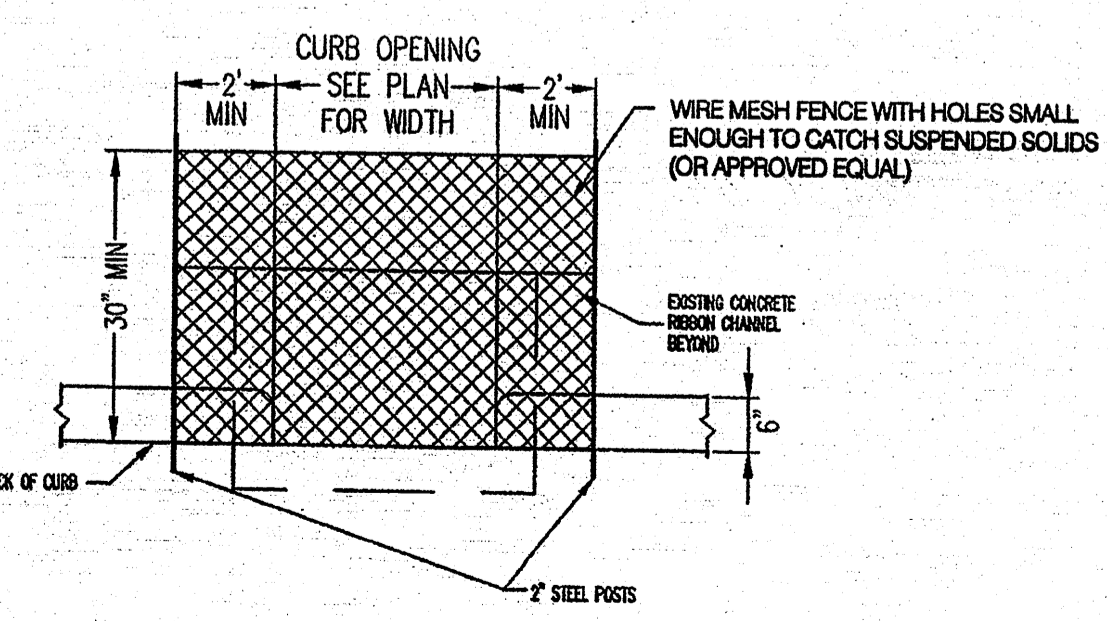
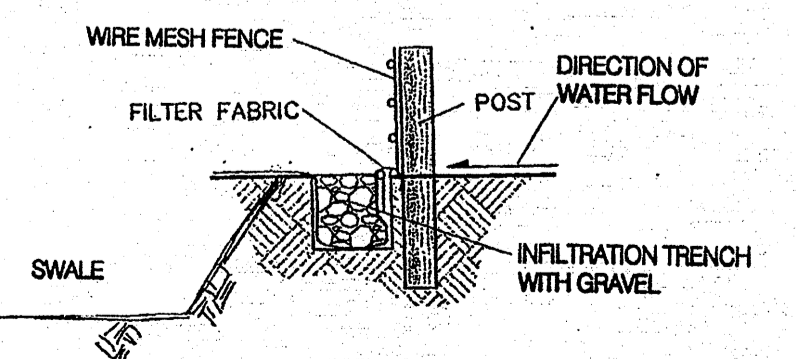
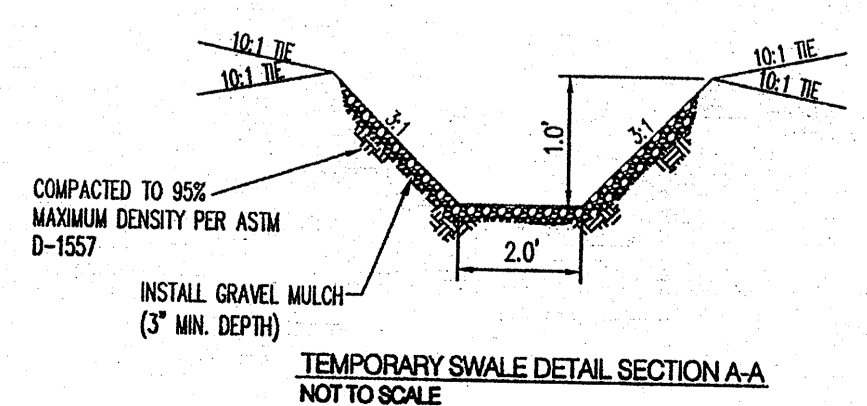
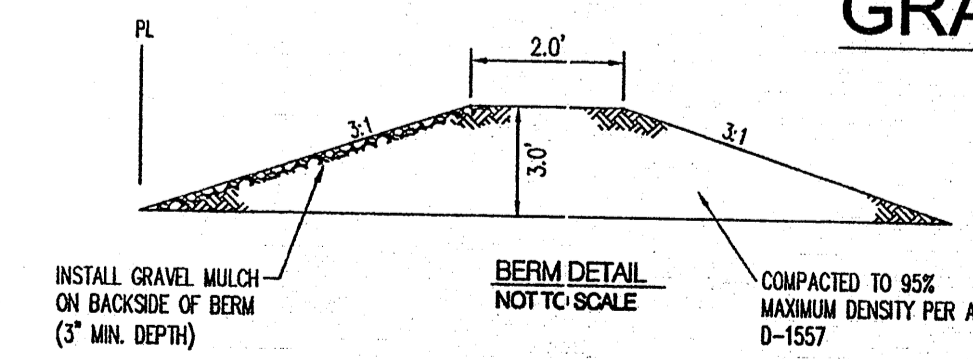

CINEMARK
CENTURY RIO 24

PNM FACILITY

CHAMA RIVER BREWING
PRIVATE DRIVE

PAN AMERICAN NE

FUDDRUCKERS

DEMOLITION PLAN

Fri, 29-Mar-2013 - 9:14:am, Plotted by: BPATTERSON

DEMOLITION KEYED NOTES

- (A) REMOVE AND DISPOSE OF EXISTING BUILDING. (SEE ALSO DEMOLITION NOTE 14)
- (B) REMOVE AND DISPOSE OF EXISTING PAVEMENT.
- (C) REMOVE AND DISPOSE OF EXISTING CONCRETE.
- (D) REMOVE AND DISPOSE OF EXISTING CURB & GUTTER.
- (E) REMOVE AND DISPOSE OF EXISTING LIGHT POLE.
- (F) REMOVE AND DISPOSE OF EXISTING CONCRETE SIDEWALK.
- (G) REMOVE AND DISPOSE OF EXISTING LANDSCAPE MATERIAL, SOIL, ETC. IN THIS AREA TO ALLOW FOR CONSTRUCTION OF NEW ENTRY DRIVE. COORDINATE LANDSCAPE IRRIGATION CAPPING AND CONTINUITY OF REMAINING SYSTEM.
- (H) REMOVE AND DISPOSE OF EXISTING SIGN.
- (L) REMOVE AND DISPOSE EXISTING LANDSCAPE TIMBERS, LANDSCAPING AND IRRIGATION.
- (M) REMOVE AND DISPOSE EXISTING BLOCK WALL
- (N) REMOVE AND DISPOSE EXISTING CHAIN LINK FENCING
- (O) REMOVE AND DISPOSE EXISTING METAL FENCE
- (P) REMOVE AND DISPOSE EXISTING GATE.
- (Q) REMOVE AND DISPOSE EXISTING PARKING BUMPERS
- (R) REMOVE AND DISPOSE EXISTING POST
- (S) REMOVE AND DISPOSE EXISTING LANDSCAPING ROCK
- (T) REMOVE AND DISPOSE EXISTING CAP
- (U) EXISTING FIRE HYDRANT TO REMAIN
- (V) EXISTING UNDERGROUND TELEPHONE SERVICE LINE - REMOVE AND DISPOSE
- (W) EXISTING UNDERGROUND ELECTRIC SERVICE LINE - REMOVE AND DISPOSE
- (X) EXISTING SANITARY SEWER CLEANOUT, LOCATE, REMOVE, AND DISPOSE OF UNDERGROUND SERVICE LINES
- (Y) EXISTING WATER SERVICE METER, LOCATE, REMOVE, AND DISPOSE OF UNDERGROUND SERVICE LINE
- (Z) EXISTING GASOLINE ABATEMENT MONITORING WELL, REMOVE AND DISPOSE OF, OBTAIN ALL PERMITS NECESSARY
- (AA) EXISTING UNDERGROUND SEPTIC TANK / WASTE DISPOSAL SYSTEM, REMOVE AND DISPOSE OF, INCLUDING ALL ASSOCIATED PIPING, DRAIN FIELD, ETC. EMPTY BEFORE REMOVAL AND DISPOSAL
- (AB) EXISTING TREES TO REMAIN. SEE LANDSCAPE PLAN.

DEMOLITION NOTES

1. DEMOLITION WORK CANNOT BEGIN UNTIL THE EXISTING INPLACE GAS SERVICES CUT-OFFS HAVE BEEN COORDINATED WITH THE NEW MEXICO GAS COMPANY.
2. ALL UTILITY COMPANY FACILITIES AND UNDERGROUND UTILITY LINES, WHETHER INDICATED OR NOT INDICATED ON THE DRAWING, SHALL BE REMOVED AS REQUIRED FOR NEW CONSTRUCTION AND CAPPED. CONTRACTOR TO COORDINATE THIS WORK WITH UTILITY COMPANIES.
3. CONTRACTOR TO COORDINATE UTILITY DEMOLITION WITH UTILITY RELOCATION AND PROPOSED UTILITY CONSTRUCTION.
4. ALL DEMOLITION SHALL BE REMOVED FROM SITE AND DISPOSED OF IN A LEGAL MANNER.
5. DEMOLITION SHALL PROCEED ONLY WITH THE PHASING OF THE CONSTRUCTION WORK SO THAT DEMOLITION DOES NOT OCCUR UNTIL CONSTRUCTION IS IMMINENT.
6. CONTRACTOR SHALL COORDINATE WORK INDICATED ON THE SITE DEMOLITION PLANS WITH THE CONSTRUCTION PLANS TO DETERMINE SPECIFIC REMOVAL LIMITS.
7. CONTRACTOR IS RESPONSIBLE FOR ALL VEHICULAR AND PEDESTRIAN TRAFFIC CONTROL. CONTRACTOR SHALL COORDINATE WITH NEW MEXICO DEPARTMENT OF TRANSPORTATION (NDOT) FOR WORK WITHIN THE PUBLIC RIGHT-OF-WAY AND WITH OWNER'S REPRESENTATIVE FOR WORK ON-SITE, AND / OR WORK ASSOCIATED WITH THE PRIVATE DRIVE.
8. CONTRACTOR SHALL CONTACT THE NMDOT PRIOR TO COMMENCING ANY WORK IN THE NMDOT RIGHT-OF-WAY.
9. CONTRACTOR SHALL SUBMIT A TRAFFIC CONTROL PLAN TO THE NMDOT AT LEAST 48 HOURS PRIOR TO LANE CLOSURES AND 24 HOURS PRIOR TO LANE DROP WITHIN THE NMDOT RIGHT-OF-WAY.
10. CONTRACTOR IS RESPONSIBLE FOR DRAINAGE MANAGEMENT AND EROSION CONTROL AT ALL TIMES DURING THE CONSTRUCTION PERIOD.
11. NOT USED
12. CONTRACTOR SHALL BE RESPONSIBLE FOR ALL DEMOLITION AND UTILITY TRENCHING NECESSARY TO PERFORM THE WORK SHOWN ON THE UTILITY AND ELECTRICAL PLANS.
13. ALL PAVEMENT CUTS WITHIN THE PUBLIC RIGHT-OF-WAY AND / OR PRIVATE DRIVE SHALL BE STRAIGHT LINE SAW CUTS. ANY PAVEMENT DAMAGED DURING CONSTRUCTION SHALL BE REMOVED AND REPLACED WITH THE FULL PAVEMENT SECTION.
14. DEMOLITION OF EXISTING BUILDING / STRUCTURE SHALL INCLUDE ALL HAZARDOUS MATERIAL ABATEMENT MEASURES REQUIRED BY LAW. CONTRACTOR RESPONSIBLE FOR EVALUATING, TESTING, INVESTIGATING ETC. EXISTING STRUCTURE CONDITION, MATERIALS, ETC. AS A PART OF THE STRUCTURE DEMOLITION PROCESS.
15. DEMOLITION OF NOTED ITEMS SHALL INCLUDE REMOVAL OF ALL ABOVE AND BELOW SURFACE FOUNDATION COMPONENTS, FOOTINGS, PILES, STANDARDS, STRUCTURAL EASEMENTS, ETC.

LEGEND

- FND-AMAFCA BRASS CAP
- ⊙ FND-BRASS CAP
- MANHOLE-COMMUNICATION
- ⊙ SAS-CLEANOUT
- ⊙ STORM DRAIN (DROP INLET)
- ⊙ PULLBOX-ELECTRIC
- ⊙ ELECTRICAL TRANSFORMER
- ⊙ GUY WIRE ANCHOR/GUY WIRE
- ⊙ POWER POLE
- ⊙ FND-CHEELED MARK IN CONCRETE
- ⊙ BUILDING-FINISHED FLOOR
- ⊙ FENCE-CORNER
- ⊙ FIRE HYDRANT
- ⊙ FND-IRON PIPE
- ⊙ FND-NAIL AND SHINER
- ⊙ FND-REBAR WITH CAP
- ⊙ FND-REBAR NO CAP
- ⊙ INVERT ELEVATION
- ⊙ LANDSCAPE LIGHT
- ⊙ LIGHT POLE
- ⊙ LIGHT POLE-METAL
- ⊙ POST-PIPE/STEEL
- ⊙ MANHOLE-SANITARY SEWER
- ⊙ SPRINKLER CONTROL VALVE/BOX
- ⊙ SIGN-TRAFFIC
- ⊙ SET-MAIL
- ⊙ SPRINKLER HEAD
- ⊙ GROUND SHOT
- ⊙ TOP OF CONCRETE (ROADWAY)
- ⊙ TOP OF PAVEMENT (SPOT ELEVATION)
- ⊙ TELEPHONE RELAY BOX
- ⊙ FND-U.S.G.L.O. BRASS CAP
- ⊙ METER-WATER
- ⊙ WATER VALVE
- ⊙ WATER VALVE CAN
- ⊙ SET REBAR AND RED PLASTIC SURVEY CAP STAMPED "SOUNSKI PS 1753"
- LIMITS OF DEMOLITION
- ▨ DEMOLITION IN NMDOT ROW REQUIRES SEPARATE NMDOT PERMIT
- ▨ DEMOLITION IN AMAFCA CHANNEL REQUIRES SEPARATE AMAFCA APPROVAL

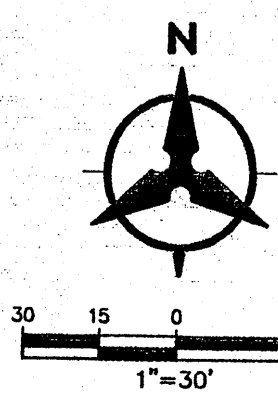

ARCHITECT:
DAVID SCOTT WINDLE, AIA

1431 GREENWAY DRIVE
SUITE 100
IRVING, TX 75038
PHONE 972.670.1288
E-MAIL scottw@dsai.com

CLIENT:
CHEDDAR'S CASUAL CAFE
2220 W. JOHN CARPENTER FWY, SUITE 540
IRVING, TX 75063
EMAIL: www.cheddars.com

CHEDDAR'S CASUAL CAFE

4865 PAN AMERICAN WEST FWY NE
ALBUQUERQUE, NM

CLIENT: CHEDDAR'S CASUAL CAFE

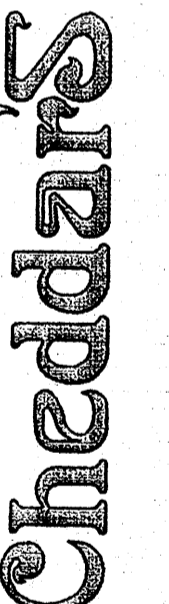

DATE	DESCRIPTION
12/20/12	ISSUE FOR PERMIT
1/29/13	SEPTIC TANK REMOVAL
3/29/13	TREE REMAINING NOTE

DEMOLITION PLAN

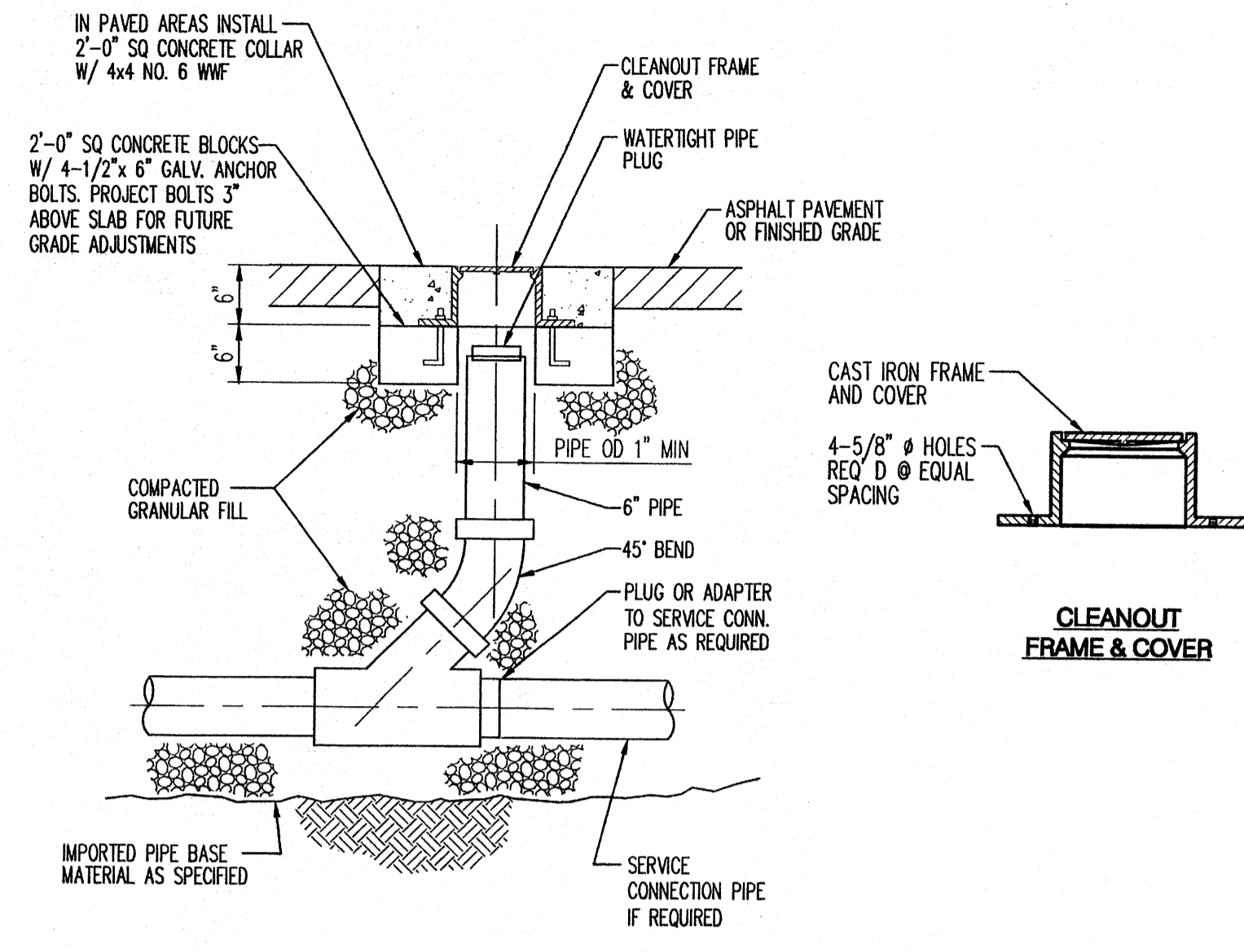
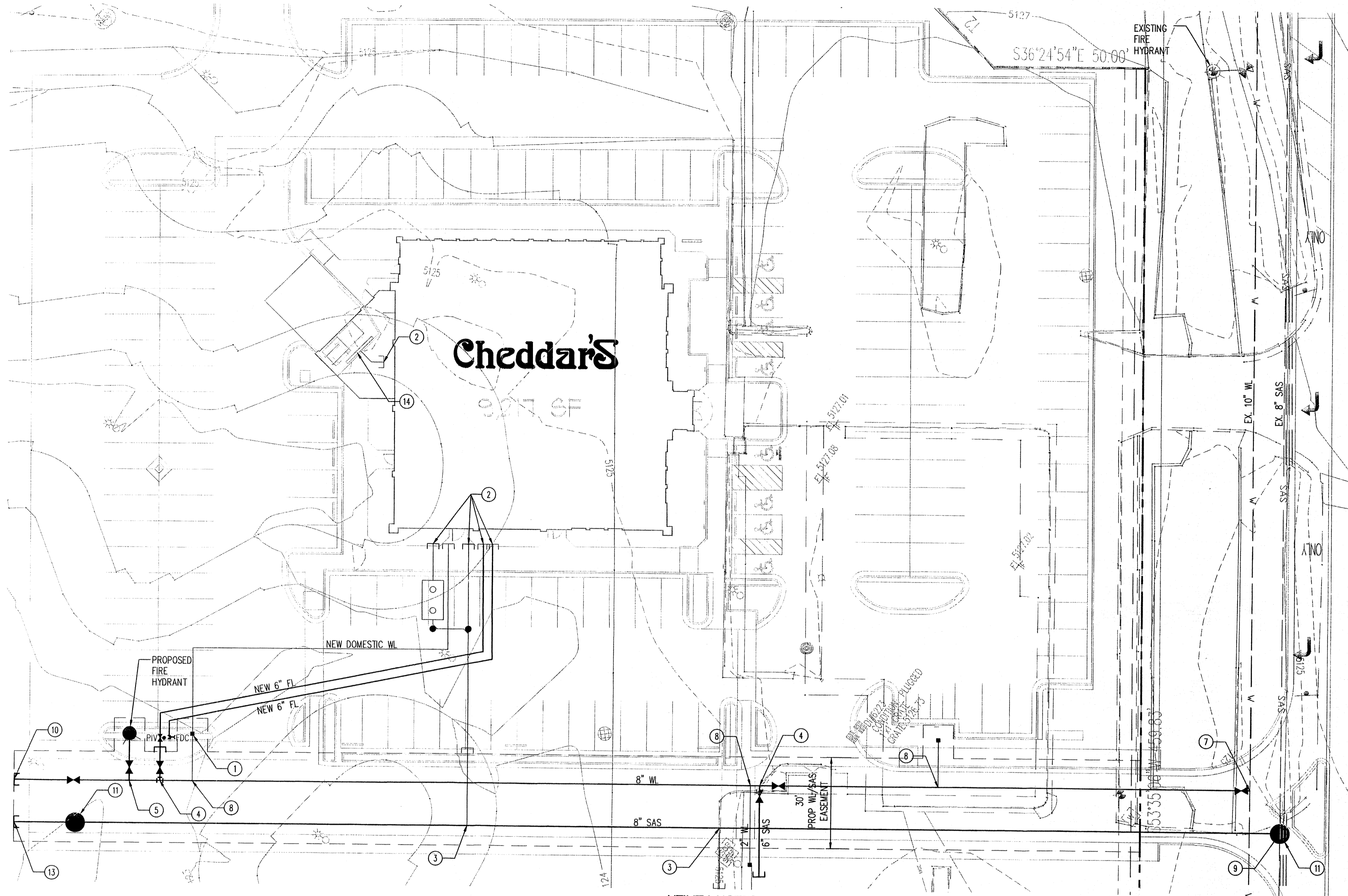

CLEANOUT
N.T.S.

UTILITY KEYED NOTES

1. INSTALL REDUCED PRESSURE BACKFLOW PREVENTER W/ HOT BOX PER COA STD. DWG. 2385
2. TIE TO WITHIN 5' OF BUILDING
3. INSTALL NEW CLEAN-OUT PER DETAIL THIS SHEET
4. INSTALL 8"x8"x6" TEE W/ RESTRAINED JOINTS, 1-6" GATE VALVE W/ BOX & LID PER COA STD DWG 2326.
5. INSTALL 8"x8"x6" TEE, 6" GATE VALVE W/ BOX & LID PER COA STD DWG 2326 & 1-FIRE HYDRANT COMPLETE PER COA STD DWG 2340.
6. REMOVE & REPLACE EXISTING ASPHALT, CURB & GUTTER AND SIDEWALK PER COA STD. DWG. 2465
7. CONNECT TO EXISTING 10" WATER LINE, NON-PRESSURE CONNECTION. INSTALL 10"x10"x8" TEE W/ RESTRAINED JOINTS, 1-8" GATE VALVE W/ BOX & LID PER COA STD DWG 2326.
8. 2" WATER SERVICE PER COA STD. DWG. 2363
9. TIE TO EXISTING SAS
10. INSTALL 8" GATE VALVE W/ BOX & LID PER COA STD. DWG. 2326, INSTALL 8" WL CAP
11. 4' SAS MH
12. EXISTING CULVERT
13. 8" SAS PLUG
14. TRENCH DRAIN

UTILITY NOTES

1. THIS CONTRACTOR SHALL BE RESPONSIBLE FOR THE COMPLETE INSTALLATION OF ALL WORK RELATED TO MECHANICAL UTILITIES AS SHOWN ON THIS PLAN INCLUDING: TRENCHING, BACKFILL, SUPPORTS, CLEANOUT PADS, SERVICE STOPS AND BOXES, SERVICE LINES, TESTING, CLEANING, AND STERILIZING. ANY WORK NOT ACCEPTED BY THE ARCHITECT OR ENGINEER DUE TO IMPROPER WORKMANSHIP OR LACK OF PROPER COORDINATION SHALL BE REMOVED AND CORRECTLY INSTALLED AT THE CONTRACTOR'S EXPENSE, AS DIRECTED.
2. MINIMUM DEPTHS OF COVER SHALL BE: 36" FOR WATERLINES AND 48" FOR SEWER, EXCEPT AT BUILDING CONNECTION.
3. ALL WORK DETAILED ON THESE PLANS TO BE PERFORMED UNDER CONTRACT SHALL, EXCEPT AS OTHERWISE STATED OR PROVIDED OF HEREON, BE CONSTRUCTED IN ACCORDANCE WITH THE IAPMO UNIFORM PLUMBING CODE & NFPA 24, LATEST EDITION.
4. UTILITY LINES SHALL BE INSTALLED PRIOR TO PAVEMENT, CURB AND GUTTER, AND/OR SIDEWALK, AS APPLICABLE.
5. ROUGH GRADING OF SITE (+0.5') SHALL BE COMPLETED PRIOR TO INSTALLATION OF UTILITY LINES.
6. CONTRACTOR WILL BE RESPONSIBLE FOR CONNECTIONS TO BUILDING DRAIN LINES AND ALL NECESSARY FITTINGS.
7. ALL VALVES SHALL BE ANCHORED PER COA STANDARD DWG. 2333.
8. FIRE LINES SHALL USE PIPE MATERIALS UNDERWRITERS LABORATORIES LISTED AND APPROVED FOR FIRE SERVICE.
9. CONTRACTOR SHALL BE RESPONSIBLE FOR ALL WATER METER, FIRE LINE, AND SEWER HOOKUP FEES FOR INSTALLATIONS. OWNER SHALL BE RESPONSIBLE FOR UTILITY EXPANSION CHARGES, PRORATA AND OTHER SPECIAL ASSESSMENTS.
10. CONTRACTOR SHALL VERIFY INVERTS AND LOCATIONS OF EXISTING WATER/SAS LINES PRIOR TO BEGINNING WORK. ALL CONFLICTS SHALL BE BROUGHT TO ATTENTION OF THE ENGINEER AND RESOLVED PRIOR TO BEGINNING WORK.
11. CONTRACTOR SHALL NOTIFY THE AUTHORITY HAVING JURISDICTION PRIOR TO INSTALLATION OF FIRE SERVICE LINES, AND PRIOR TO TESTING OF ALL WATERLINES. CONTRACTOR SHALL COMPLETE, SIGN, AND SUBMIT THE "CONTRACTOR'S MATERIAL & TEST CERTIFICATE FOR UNDERGROUND PIPING" IN ACCORDANCE WITH NFPA 24.
12. SCREENING SURROUNDING GROUND MOUNTED TRANSFORMERS AND UTILITY PADS SHALL BE LOCATED 10' MIN. CLEAR FROM THE FRONT OF THE EQUIPMENT AND 6' MIN. CLEAR FROM THE REMAINING 3 SIDES.

GENERAL NOTES

1. PRIOR TO BEGINNING ANY WORK WITHIN THE CITY OF ALBUQUERQUE RIGHT-OF-WAY THE CONTRACTOR SHALL OBTAIN A MINI-WORK ORDER FROM THE ALBUQUERQUE BERNALILLO COUNTY WATER UTILITY AUTHORITY (ABCWUA) TO CONSTRUCT THE UTILITY SERVICE CONNECTIONS (WATER, AND FIRE) WITHIN PINON VERDE RD.
2. ALL WORK DETAILED ON THESE PLANS TO BE PERFORMED UNDER CONTRACT SHALL, EXCEPT AS OTHERWISE STATED OR PROVIDED FOR HEREON, BE CONSTRUCTED IN ACCORDANCE WITH THE NEW MEXICO PUBLIC WORKS STANDARD SPECIFICATIONS FOR PUBLIC WORKS CONSTRUCTION, 1986 EDITION AS REVISED THROUGH CURRENT UPDATE.
3. TWO WORKING DAYS PRIOR TO ANY EXCAVATION, THE CONTRACTOR MUST CONTACT NEW MEXICO ONE CALL SYSTEM (260-1990) FOR LOCATION OF EXISTING UTILITIES.
4. PRIOR TO CONSTRUCTION, THE CONTRACTOR SHALL EXCAVATE AND VERIFY THE HORIZONTAL AND VERTICAL LOCATIONS OF ALL OBSTRUCTIONS. SHOULD A CONFLICT EXIST, THE CONTRACTOR SHALL NOTIFY THE ENGINEER IMMEDIATELY SO THAT THE CONFLICT CAN BE RESOLVED WITH A MINIMUM AMOUNT OF DELAY.
5. CONTRACTOR SHALL COORDINATE WITH THE ALBUQUERQUE BERNALILLO COUNTRY WATER UTILITY AUTHORITY (ABCWUA) FIVE (5) WORKING DAYS IN ADVANCE OF ANY WORK THAT MAY AFFECT EXISTING PUBLIC WATER OR SEWER UTILITIES. EXISTING VALVES TO BE OPERATED BY CITY PERSONNEL ONLY. CONTRACTOR SHALL CONTACT THE WATER SYSTEMS DIVISION THREE (3) WORKING DAYS PRIOR TO NEEDING VALVES TURNED ON OR OFF.

LEGEND

- PROPERTY LINE
- - - - - EXISTING EASEMENT
- - - - - SAS EXISTING SANITARY SEWER
- - - - - W EXISTING WATER LINE
- - - - - PROPOSED EASEMENT
- - - - - SAS PROPOSED SANITARY SEWER LINE
- PROPOSED SANITARY SEWER MANHOLE
- CD PROPOSED CLEANOUT
- WL PROPOSED WATER LINE
- V PROPOSED VALVE
- FL PROPOSED FIRE LINE
- PROPOSED HYDRANT
- PROPOSED CAP
- PROPOSED WATER METER
- PIV PROPOSED POST INDICATOR VALVE

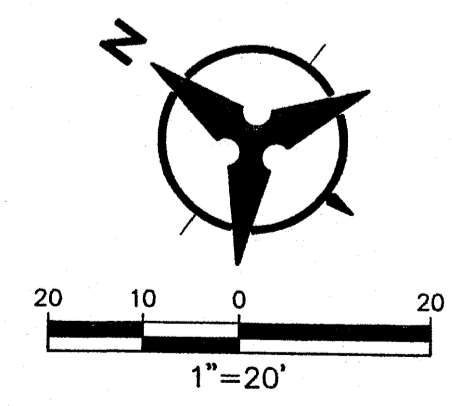

Bohannon & Huston

FEBRUARY 5, 2013



CHEDDAR'S
CHEESE CURRY, ETC.

CONCEPTUAL
UTILITY PLAN
SCALE AS NOTED

REV.	DATE	DESCRIPTION

PROJECT: 4

Finish Legend

-  Austin Chalk Limestone
-  Old Chicago Brick
-  Jumbo Cedar Shake Shingles
-  Standing Seam Copper
-  Standing Seam Bronze
-  Painted EIFS, Sahara Sand Tan
-  Stained Cedar, Charwood Brown



South Elevation



West Elevation

SHEET 5



Cheddar's Casual Cafe
 Albuquerque, New Mexico

DAVID SCOTT WINDLE, AIA

SIGNAGE PLAN

277v

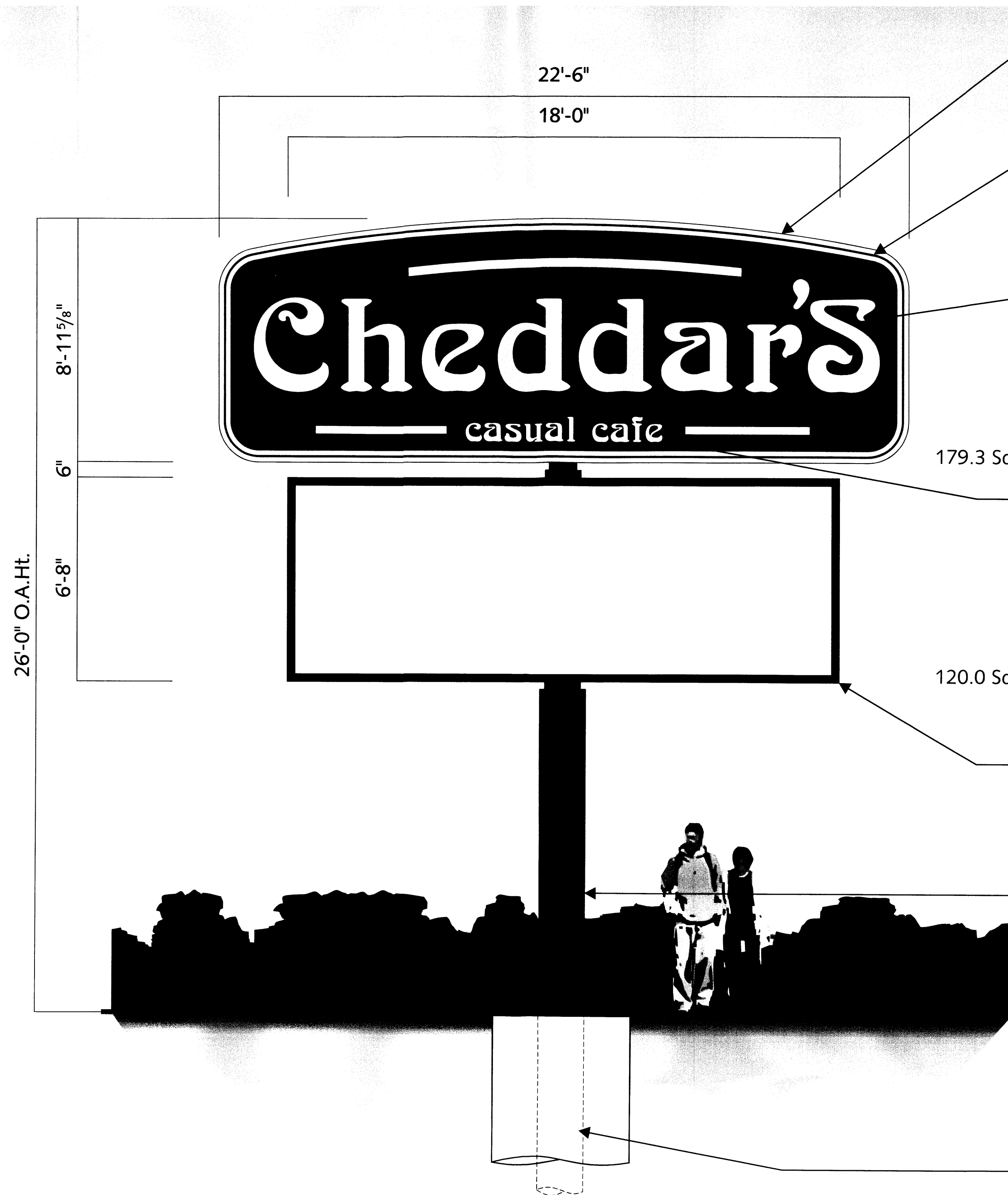

- D/F CABINET - .080 ALUMINUM FACES w/ .063 ALUMINUM FILLER - PAINT FILLER SW GENESIS SATIN BLACK - PAINT FACES w/ DUPONT 143 RED
- 3" DEEP ALUMINUM CHANNEL BORDER - .063 BACKS w/ .050 RETURNS PAINTED SW GENESIS TO MATCH DUPONT CENTARI #4775 CREAM - SINGLE TUBE 15mm CLEAR RED NEON BORDER - 30 M.A. 277v
- 3" DEEP ALUMINUM FAB. OPEN CHANNEL LETTERS "Cheddar'S" - .063 BACKS w/ .050 RETURNS - PAINT INSIDE SW GENESIS TO MATCH DUPONT CENTARI #4775 CREAM - PAINT OUTSIDE RETURNS SATIN BLACK - ILLUMINATED w/ CLEAR RED EXPOSED NEON (1 OR 2 AS REQUIRED) - 30 M.A. 277v
- ROUTED COPY "casual cafe" BACKED UP w/ 7328 WHITE PLEXIGLAS - INTERNALLY ILLUMINATION w/ WHITE AGILIGHT SIGNRAYZ CORE 6500 WHITE LED'S 277v POWER SUPPLY
- ALL ACCENTS TO BE .063" FLAT CUT-OUT ALUMINUM PAINTED SW GENESIS TO MATCH DUPONT CENTARI #4775 CREAM - ILLUM. w/ SINGLE TUBE 15mm EGL CASINO GOLD EXPOSED NEON - 30 M.A.
- (2) S/F FAB. ALUM. SIGN CABINETS & 3" RETAINERS PAINTED FILLER SW GENESIS SATIN BLACK - COMMON BLACK FILLER BETWEEN - BLANK WHITE FLEXIBLE FACES - 800mA H.O. FLUORESCENT ILLUM.
- STEEL PIPE SIGN SUPPORT w/ STUB PIPE INTO CABINET - PRIMED & PAINTED SATIN BLACK
- NOTE: SIZE OF PIPE TO BE DETERMINED BY ENGINEERING & LOCAL CODE & CONDITIONS
- UNDERGROUND ELECTRICAL SERVICE TO SIGN BY CUSTOMER'S ELECTRICIAN COORDINATE w/ CHANDLER AS TO REQUIREMENTS
- CONCRETE PIER TYPE FOUNDATION
- NOTE: FOUNDATION TO BE DETERMINED BY ENGINEERING & LOCAL CODES & CONDITIONS

A D/F PYLON SIGN
(1) REQUIRED - MANUFACTURE & INSTALL

299.3 Sq.Ft.
SCALE: 3/16" = 1'-0"

277v

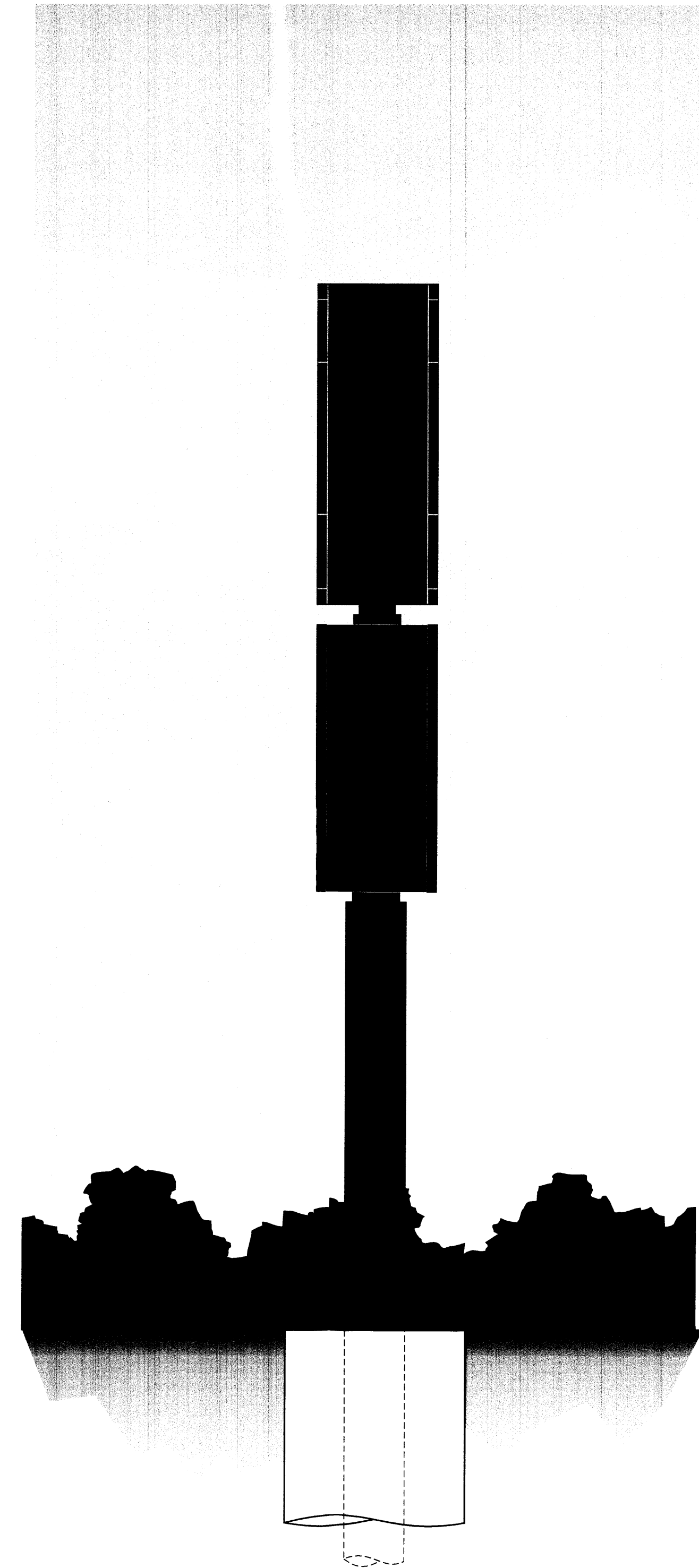

A END VIEW

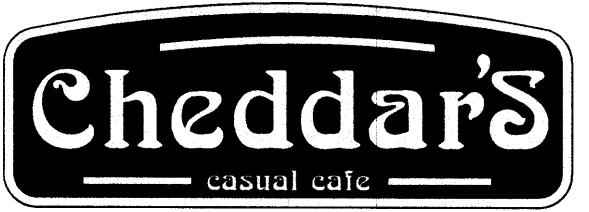

Design #	12-2186R5
Sheet	2 of 5
Client	Cheddar'S
Address	4865 PAN AMERICA WAY ALBUQUERQUE, NM
Account Rep.	RAJ / DMCF
Designer	MAB
Date	9-21-12

Approval / Date	
Client	
Sales	
Estimating	
Art	
Engineering	
Landlord	

Revision / Date	
r1-BR/10-16-12:Del "A" opt 1, add square footage to "B" & "C".	
r2-KMc/11-28-12:add notes	
R3-12/19/12(CJR): Changed elev.	
R4 RFF 01.11.13 update	
R5 PC 15JAN2013 ADD SITE PLAN, & PAGE NUMBERS	

Chandler Signs
Brand Image Begins Here®
www.chandlersigns.com

- 3201 Manor Way Dallas, TX 75235
214-902-2000 Fax 214-902-2044
- 12106 Valliant Drive San Antonio, TX 78216
210-349-3804 Fax 210-349-8724
- 1335 Park Center Drive, Unit C Vista, CA 92081
760-967-7003 Fax 760-967-7033
- 2584 Sand Hill Point Circle Davenport, FL 33837
863-420-1100 Fax 863-424-1160
- 963 Baxter Avenue, Suite 200 Louisville, KY 40204
502-479-3075 Fax 502-412-0013
- 37 Waterfront Park Court Dawsonville, GA 30534
800-851-7062 Fax 210-349-8724
- P.O. Box 125 206 Doral Drive Portland, TX 78374
361-563-5599 Fax 361-643-6533

This drawing is the property of Chandler Signs, L.L.P. and all rights to its use for reproduction are reserved by Chandler Signs, L.L.P.

UL
LISTED
ELECTRICAL
EQUIPMENT
CLASSIFIED
BY CUSTOMER

SHEET 8



North Elevation

- Finish Legend**
-  Austin Chalk Limestone
 -  Old Chicago Brick
 -  Jumbo Cedar Shake Shingles
 -  Standing Seam Copper
 -  Standing Seam Bronze
 -  Painted EIFS, Sahara Sand Tan
 -  Stained Cedar, Charwood Brown



East Elevation

Sheet 6

Cheddar's

Cheddar's Casual Cafe
Albuquerque, New Mexico

DAVID SCOTT
WINDLE, AIA

120v

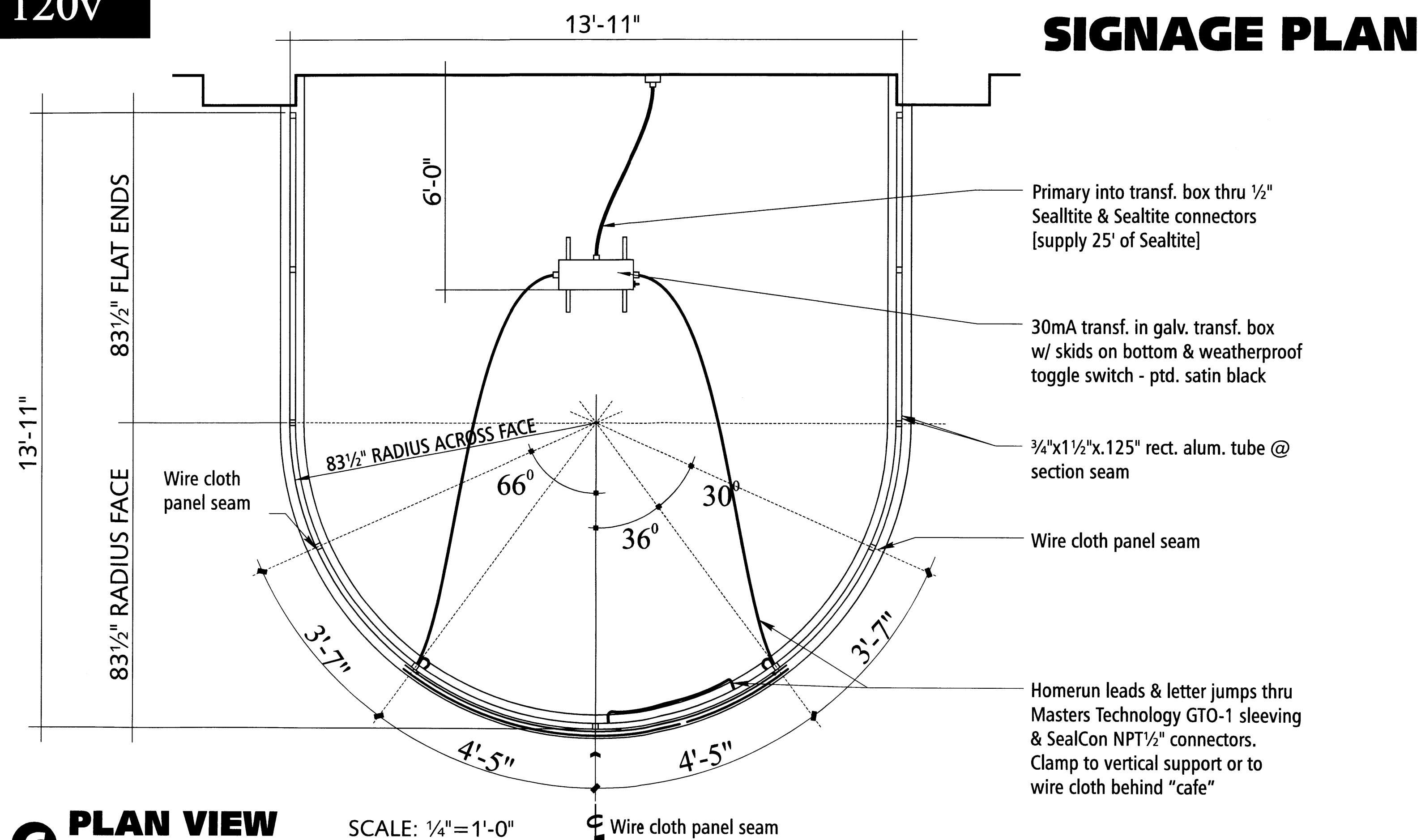

PLAN VIEW SCALE: 1/4"=1'-0"

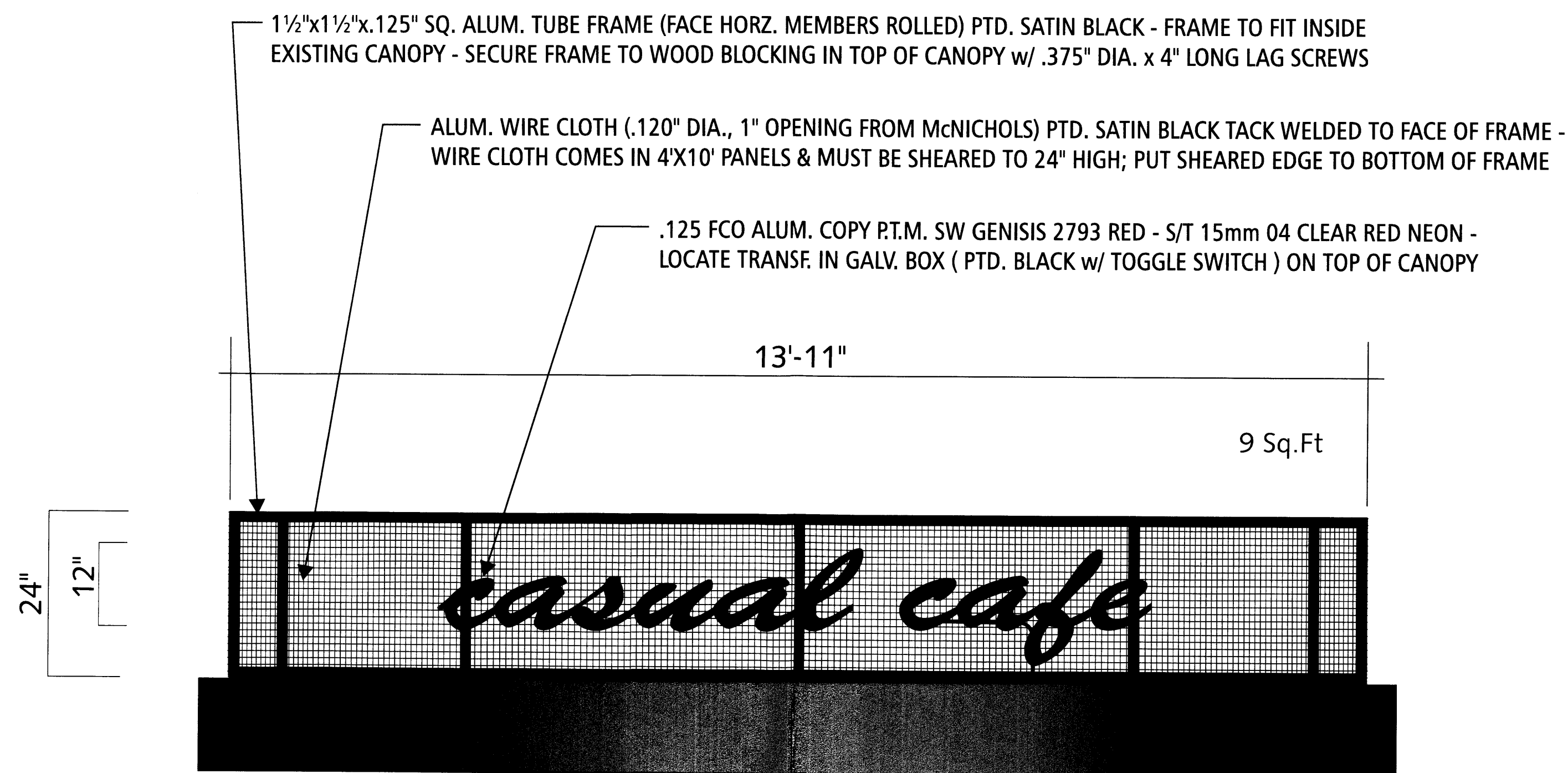

FRONT VIEW (SKEWED VIEW) SCALE: 3/8"=1'-0"
(1) REQUIRED - MFR. & INSTALL

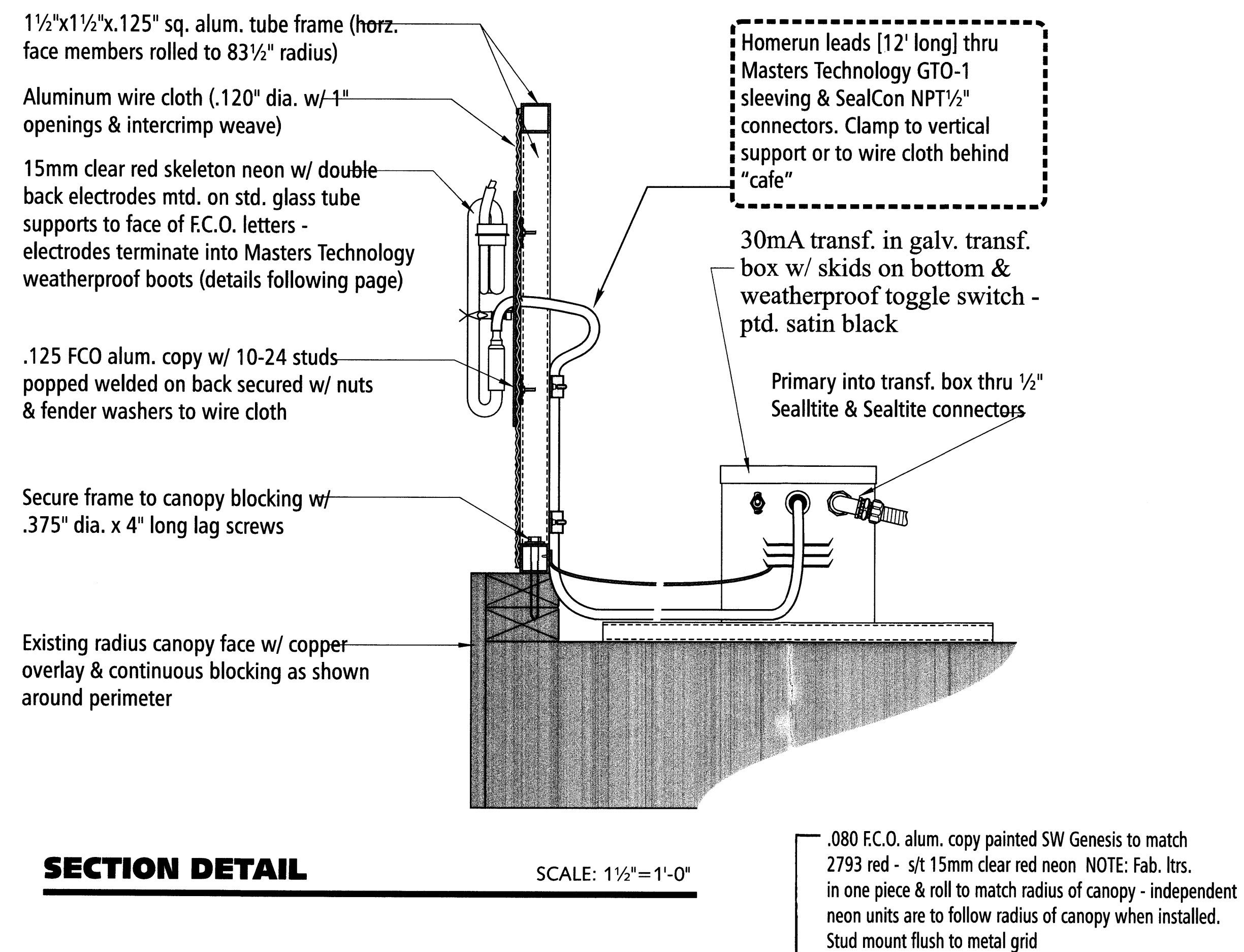

SECTION DETAIL SCALE: 1 1/2"=1'-0"



FCO LETTER LAYOUT (FLAT VIEW) SCALE: 1/2"=1'-0"
MFR. AND INSTALL (1) SET FCO LETTERS WITH S/T NEON ON RADIUS METAL GRID

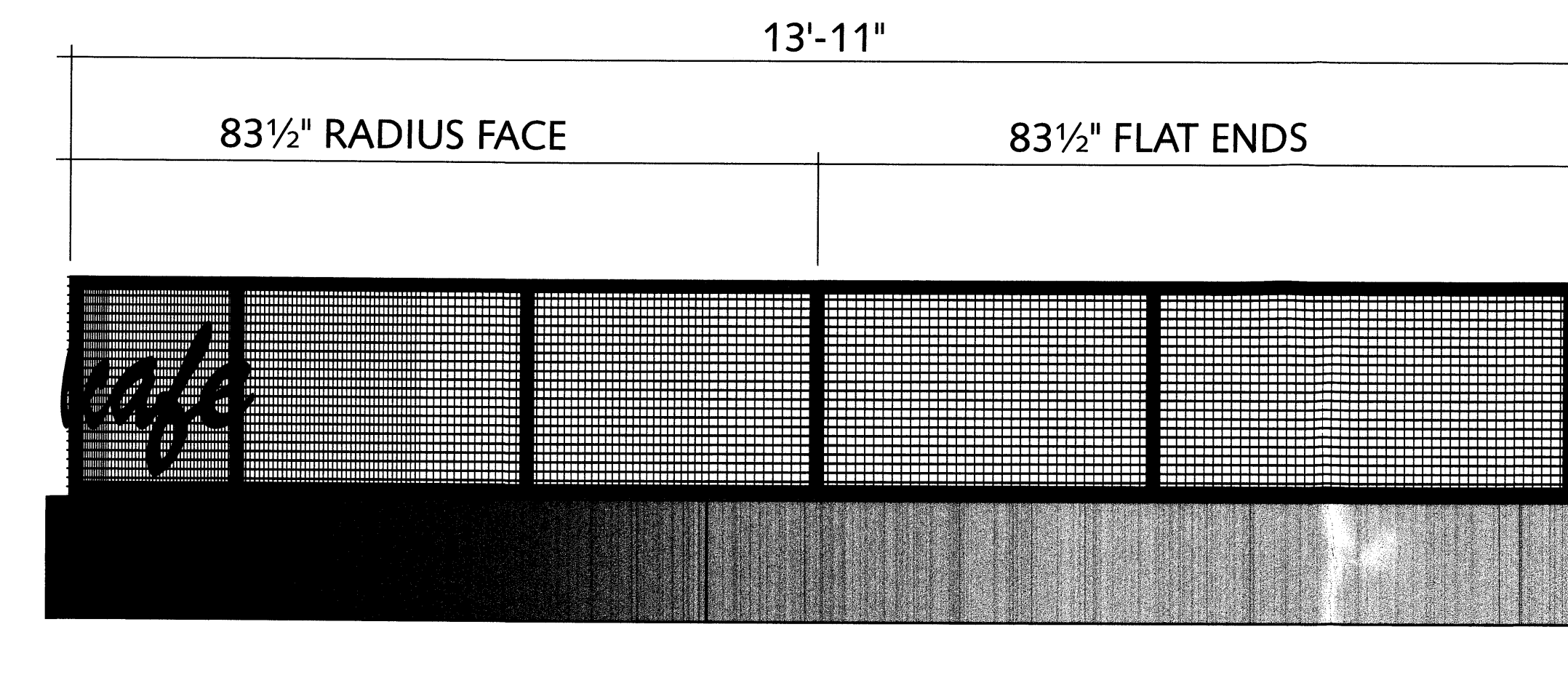

SIDE VIEW SCALE: 3/8"=1'-0"

Cheddar's
casual cafe

Design #	12-2186R5
Sheet	4 of 5
Client	Cheddar's
Address	4865 PAN AMERICA WAY ALBUQUERQUE, NM
Account Rep.	RAJ / DMcF
Designer	MAB
Date	9-21-12

Approval / Date	
Client	
Sales	
Estimating	
Art	
Engineering	
Landlord	

Revision / Date	
R1-BR/10-16-12:Del "A" opt 1, add square footage to "B" & "C".	
R2-KMc/11-28-12:add notes	
R3-12/19/12(CJR): Changed elev.	
R4 RFF 01.11.13 update	
R5 [PC] 15JAN2013 ADD SITE PLAN & PAGE NUMBERS	

Chandler Signs
Brand Image Begins Here
www.chandler signs.com

3201 Manor Way Dallas, TX 75235
214-902-2000 Fax 214-902-2044

12106 Valliant Drive
San Antonio, TX 78216
210-349-3804 Fax 210-349-8724

1335 Park Center Drive, Unit C
Vista, CA 92081
760-967-7003 Fax 760-967-7033

2584 Sand Hill Point Circle
Davenport, FL 33837
863-420-1100 Fax 863-424-1160

963 Baxter Avenue, Suite 200
Louisville, KY 40204
502-479-3075 Fax 502-412-0013

37 Waterfront Park Court
Dawsonville, GA 30534
800-851-7062 Fax 210-349-8724

P.O. Box 125 206 Doral Drive
Portland, TX 78374
361-563-5599 Fax 361-643-6533

This drawing is the property of Chandler Signs, L.L.P. and all rights to its use for reproduction are reserved by Chandler Signs, L.L.P.

FINAL ELECTRICAL
BY CUSTOMER

UL

120v
SHEET 10

Design #

12-2186R5

Sheet 1 of 5

Client

Cheddar'S

Address

4865 PAN AMERICA WAY
ALBUQUERQUE, NM

Account Rep. RAJ / DMcF

Designer MAB

Date 9-21-12

Approval / Date

Client	
Sales	
Estimating	
Art	
Engineering	
Landlord	

Revision / Date

- r1-BR/10-16-12:Del "A" opt 1, add square footage to "B" & "C".
- r2-KMc/11-28-12:add notes
- R3-12/19/12(CJR): Changed elev.
- R4 RFF 01.11.13 update
- R5|PC|15JAN2013 | ADD SITE PLAN & PAGE NUMBERS

SIGNAGE PLAN

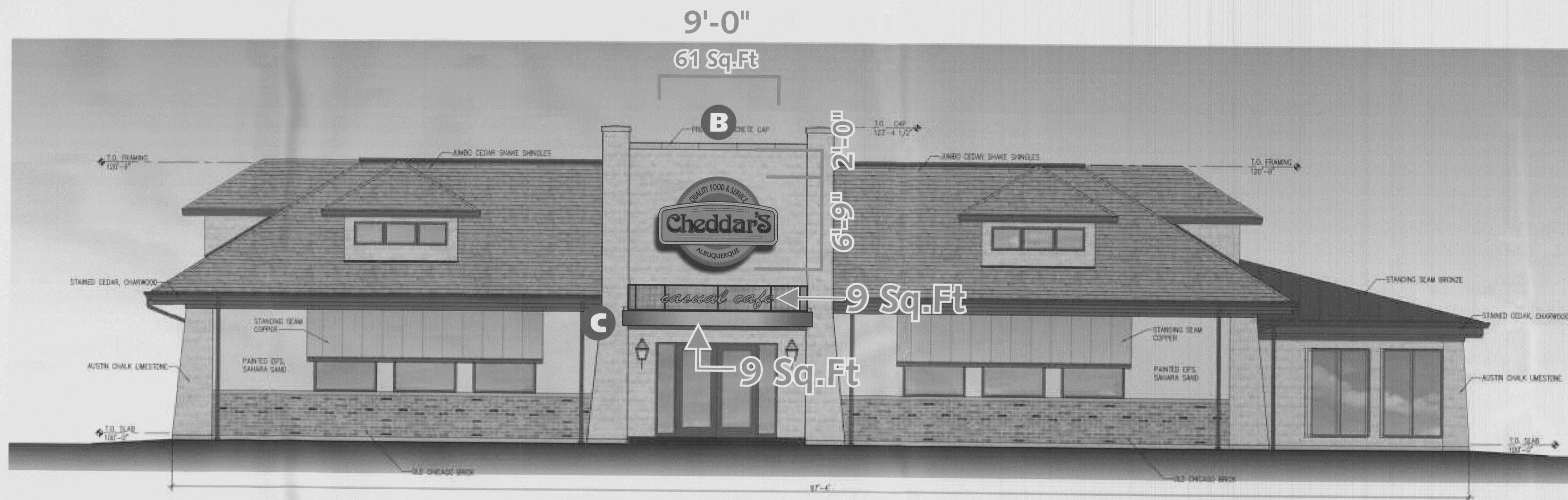

FRONT ELEVATION

NOTE: REFER TO PAGES 3 & 4 FOR DETAILS

SCALE: 3/32" = 1'-0"

Chandler Signs
Brand Image Begins Here®

www.chandler signs.com

3201 Manor Way Dallas, TX 75235
214-902-2000 Fax 214-902-2044

12106 Valliant Drive San Antonio, TX 78216
210-349-3804 Fax 210-349-8724

1335 Park Center Drive, Unit C Vista, CA 92081
760-967-7003 Fax 760-967-7033

2584 Sand Hill Point Circle Davenport, FL 33837
863-420-1100 Fax 863-424-1160

963 Baxter Avenue, Suite 200 Louisville, KY 40204
502-479-3075 Fax 502-412-0013

37 Waterfront Park Court Dawsonville, GA 30534
800-851-7062 Fax 210-349-8724

P.O. Box 125 206 Doral Drive Portland, TX 78374
361-563-5599 Fax 361-643-6533

This drawing is the property of Chandler Signs,LLP, and all rights to its use for reproduction are reserved by Chandler Signs,LLP.

FINAL ELECTRICAL CONNECTION BY CUSTOMER

UL
SIGNS TO BE MANUFACTURED IN ACCORDANCE WITH ARTICLE 600 OF THE NATIONAL ELECTRICAL CODE AND/OR OTHER APPLICABLE LOCAL CODES. THIS INCLUDES PROPER GROUNDING AND BONDING OF SIGNS. SIGN WILL BEAR UL LABELS.

SHEET 7



B S/F WALL SIGN ELEV. - MAIN I.D. SCALE: 1/2" = 1'-0"
(1) REQUIRED - MANUFACTURE AND INSTALL

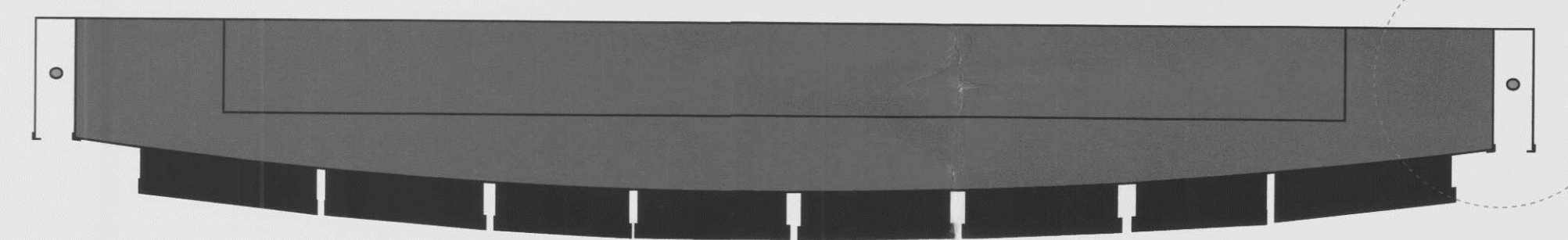

TOP VIEW SCALE: 1/2" = 1'-0"

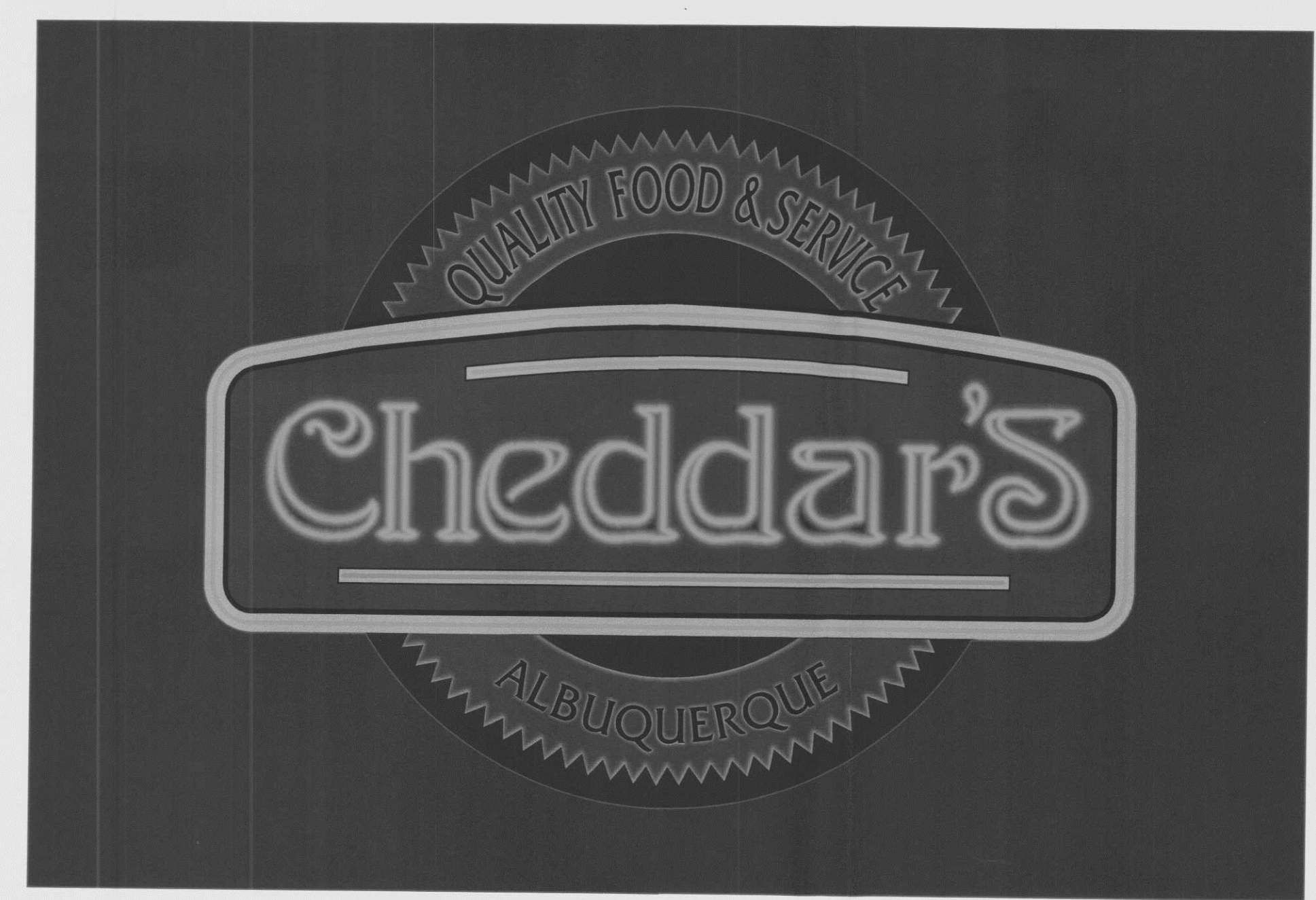

B NIGHT VIEW N.T.S.

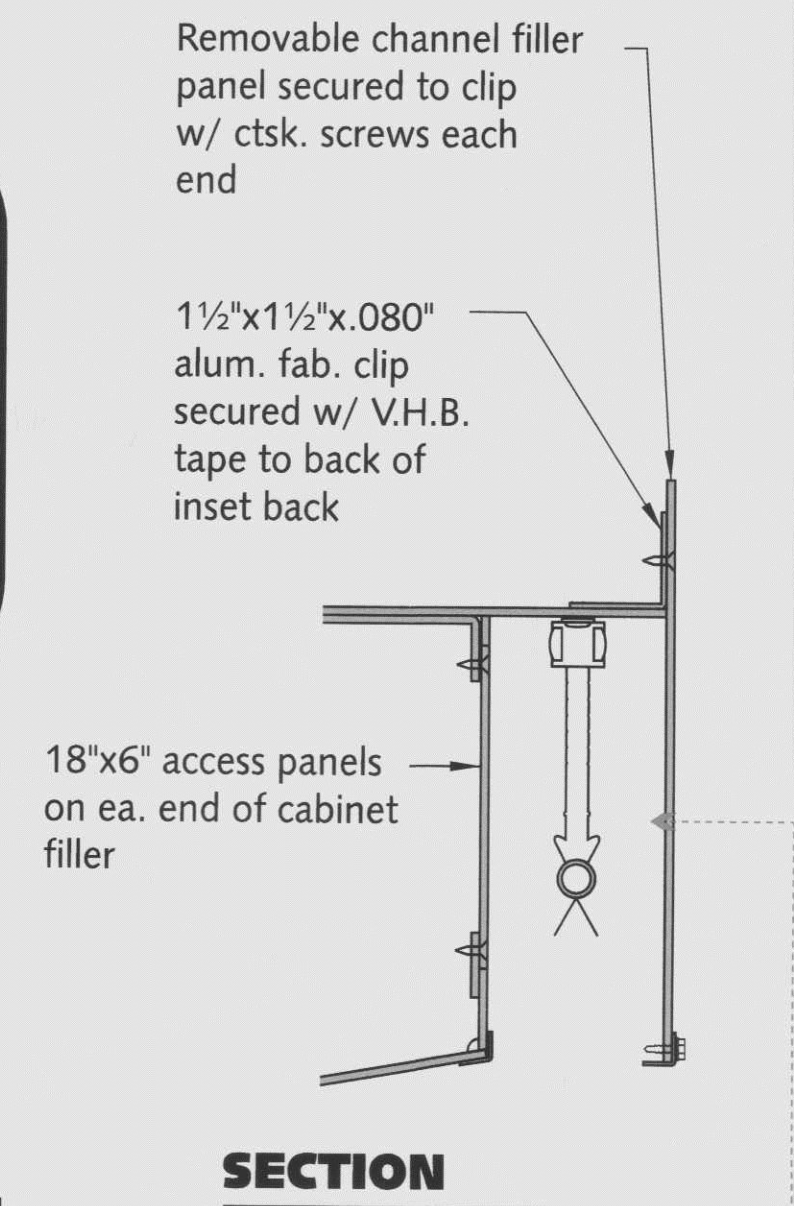

SIGNAGE PLAN

.125" alum. rolled filler section @ top & bottom welded to inset back - cove stops @ main cabinet perimeter channel / Paint metal effects iron w/ rust patina (paint interior channel w/ LEP)

.125" alum. fab. routed pan-panel face backed w/ 3/4" clear plex Paint face metal effects iron w/ rust patina (paint interior channel w/ LEP)

.032" copper mill finish overlay w/ hammered texture & protective clearcoat

.125" alum. outside perimeter open channel return - back edge welded to face of inset back where channel crosses circular seal shape top & bottom - inset back welded to inside of return each end except in areas where removable access panel for cabinet access panels are located Paint filler metal effects iron w/ rust patina Paint interior returns & back SW Genisis to match Dupont Centari 4475 cream

15mm clear red channel neon mtd. on tall tube supports

.125" alum. cam-routed main cabinet face rolled w/ 1" inset flange around perimeter for securing to filler w/ ctsk. screws

15mm clear red skeleton neon mtd. on tube supports

18"x6" access panels on ea. end of cabinet filler

3" deep alum. fab. channel letters (.050" backs & .040" returns) mtd. to main cabinet radius face - accents rolled to match face radius (adjust alum. thickness as needed to fab. rolled channels) - .187" spartech clear crylex tm plastic faces (matte side up) w/ 3/4" black trimcap retainers -unit for upper accent channel must be bent after channel is fab. due to compound curve Letter exteriors & interiors painted satin black. Accent strips exteriors painted satin black & interiors SW Genisis to match dupont Centari 4475 cream

.032" copper mill finish overlay w/ hammered texture & protective clearcoat

Transf. mtd. in main cabinet near access panels ea. end [60mA transf. on 15mm glass, 30mA transf. on 10mm glass]

1/2"x1/2"x.050" alum. fab. trim piece around center cabinet

.125" alum. cam-routed main cabinet return - back edge welded to face of inset back - radius face & corners w/ depth that varies from 9" on ends on to 13" @ center - Paint filler metal effects iron w/ rust patina

1/2"x1/2"x.050" alum. fab. trim piece around outside channel return

60watt power supply (AGI-ADV-60W-MULTI/120/277)

3/4" clear plex w/ routed out background to allow for raised copy & edge lit cove - first surface opaque black vinyl copy (inset 1/16") w/ second surface 3630-125 golden yellow vinyl

White Agilitie Tuffrayz L.E.D.

1/4" dia. weep holes in low point of bottom cove & all channel letters

B SECTION N.T.S.

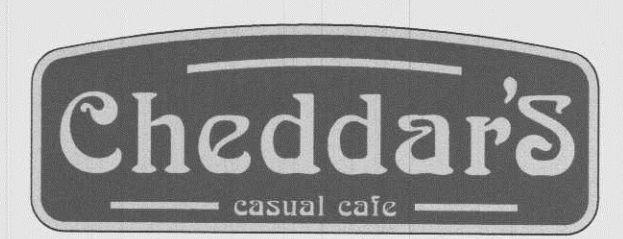
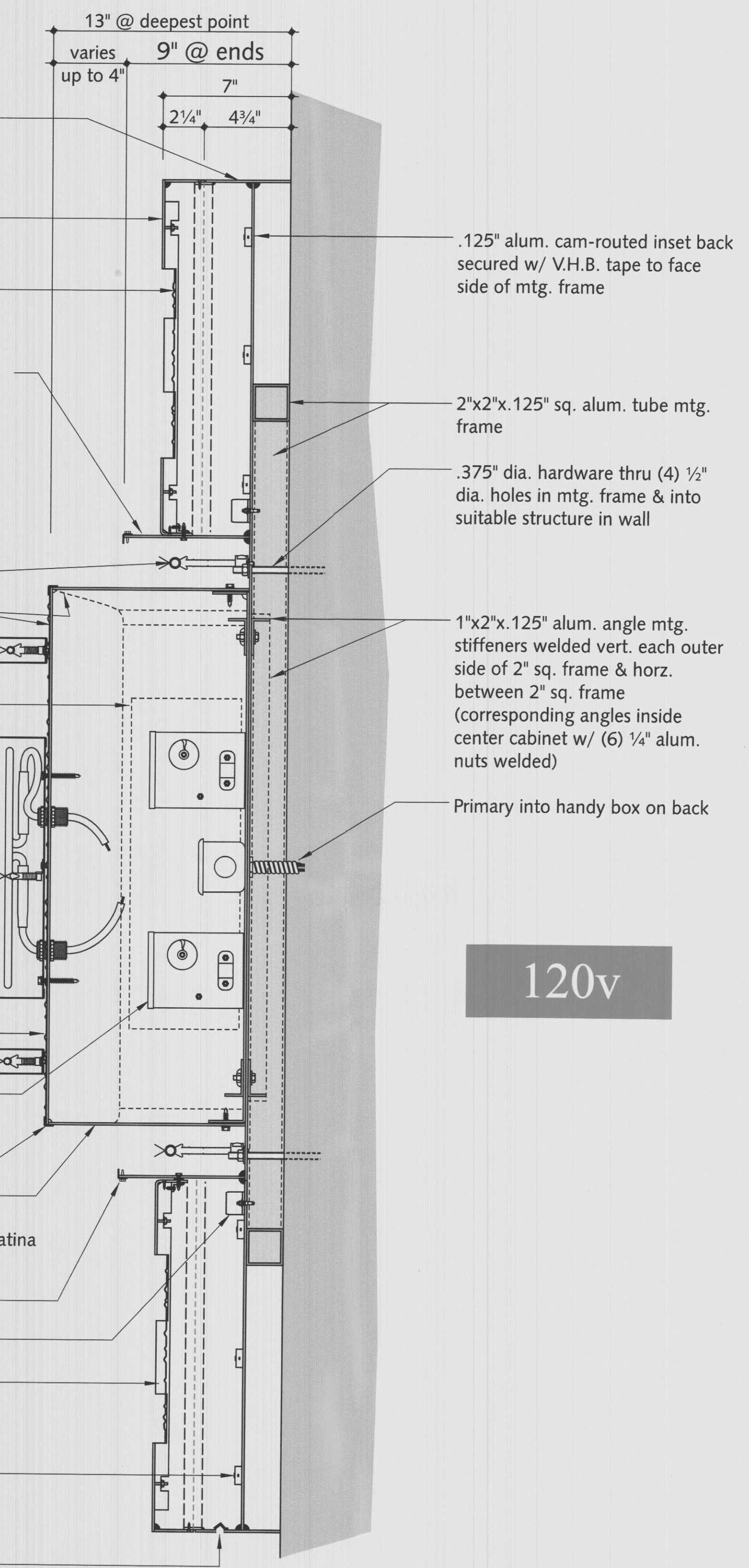

Design #
12-2186R5

Sheet **3** of **5**

Client
Cheddar's

Address
**4865 PAN AMERICA WAY
ALBUQUERQUE, NM**

Account Rep. **RAJ / DMCF**

Designer **MAB**

Date **9-21-12**

Approval / Date

Client	Revision / Date
Sales	
Estimating	
Art	
Engineering	
Landlord	

r1-BR/10-16-12:Del "A" opt 1, add square footage to "B" & "C".
r2-KMc/11-28-12:add notes
R3-12/19/12(CJR): Changed elev.
R4 RFF 01.11.13 update
R5|PCI|15JAN2013 | ADD SITE PLAN, & PAGE NUMBERS



- 3201 Manor Way Dallas, TX 75235
214-902-2000 Fax 214-902-2044
- 12106 Valliant Drive San Antonio, TX 78216
210-349-3804 Fax 210-349-8724
- 1335 Park Center Drive, Unit C Vista, CA 92081
760-967-7003 Fax 760-967-7033
- 2584 Sand Hill Point Circle Davenport, FL 33837
863-420-1100 Fax 863-424-1160
- 963 Baxter Avenue, Suite 200 Louisville, KY 40204
502-479-3075 Fax 502-412-0013
- 37 Waterfront Park Court Dawsonville, GA 30534
800-851-7062 Fax 210-349-8724
- P.O. Box 125 206 Doral Drive Portland, TX 78374
361-563-5599 Fax 361-643-6533

This drawing is the property of Chandler Signs, L.L.P. and all rights to its use for reproduction are reserved by Chandler Signs, L.L.P.

FINAL ELECTRICAL CONNECTION BY CUSTOMER

UL

SIGNS TO BE MANUFACTURED IN ACCORDANCE WITH ARTICLE 600 OF THE NATIONAL ELECTRICAL CODE AND/OR OTHER APPLICABLE LOCAL CODES THIS INCLUDES PROPER GROUNDING AND BONDING OF SIGNS SIGN WILL BEAR UL LABELS

SHEET 9

Client	
Sales	
Estimating	
Art	
Engineering	
Landlord	

- r1-BR/10-16-12:Del "A" opt 1, add square footage to "B" & "C".
- r2-KMc/11-28-12:add notes
- R3-12/19/12(CJR): Changed elev.
- R4 RFF 01.11.13 update
- R5 |PC|15JAN2013 | ADD SITE PLAN, & PAGE NUMBERS

3201 Manor Way Dallas, TX 75235
214-902-2000 Fax 214-902-2044

12106 Valliant Drive San Antonio, TX 78216
210-349-3804 Fax 210-349-8724

1335 Park Center Drive, Unit C Vista, CA 92081
760-967-7003 Fax 760-967-7033

2584 Sand Hill Point Circle Davenport, FL 33837
863-420-1100 Fax 863-424-1160

963 Baxter Avenue, Suite 200 Louisville, KY 40204
502-479-3075 Fax 502-412-0013

37 Waterfront Park Court Dawsonville, GA 30534
800-851-7062 Fax 210-349-8724

P.O. Box 125 206 Doral Drive Portland, TX 78374
361-563-5599 Fax 361-643-6533

This drawing is the property of Chandler Signs, L.L.P. and all rights to its use for reproduction are reserved by Chandler Signs, L.L.P.

FINAL ELECTRICAL CONNECTION BY CUSTOMER

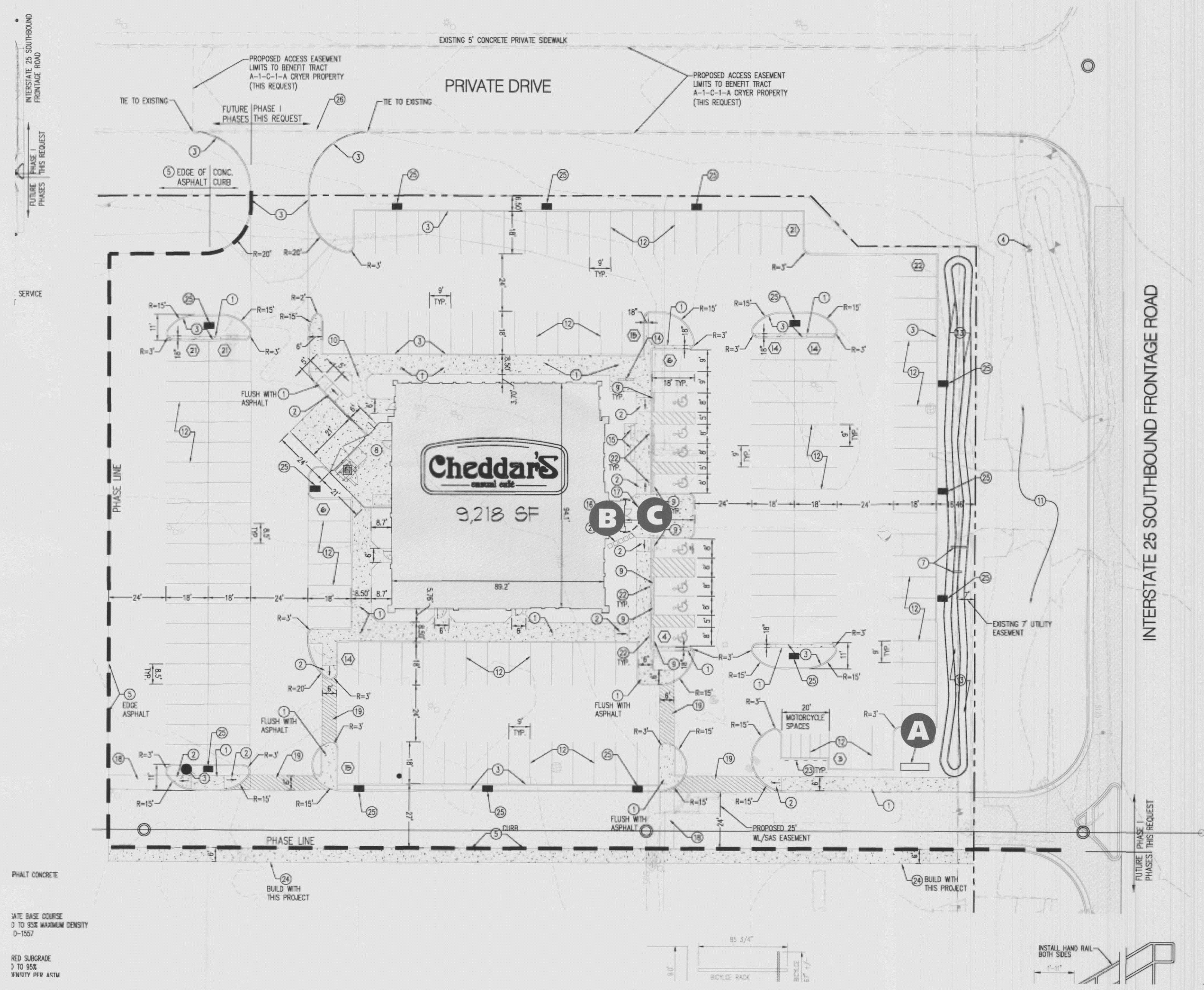
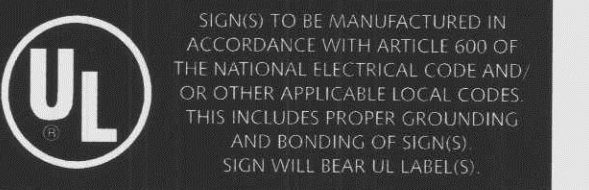

SITE PLAN

APPROX. SCALE: 1/64=1'-0"

SHEET 11